

DATA.

WARD 4, 5, 11
Sec Lines

FOR A.L. SEABRIGHT - TO HELP IN LOCATING OIL WELL S.E. 1/4 - SEC. 11.

WARD TOWNSHIP HOCKING COUNTY, OHIO.

Donated, June 1982, by
ALBERT W. SEABRIGHT, P.E., P.S.
COUNTY ENGINEER 1949 - 1964

S.C.C.C.
FEE.

CTR. EAST LINE SEC. 11
I.P. - 2" CAR AXLE



S-86°-14'-40"

B.S. - 1" PIN
S-30°-45'-10"
135.7'

OLL Stake

S.R. #216

TO MURRAY CITY

THE SUNDAY CREEK COAL CO.
FEE

N-3°-33'-E
2679.31'

B.S. - 1" I.P.
N-33°-28'-E
75.03'

SECTION CORNER
I.P. - 2" CAR AXLE

S-85°-47'-E
5290.23'

B.S. PIN - 1"
S-85°-44'-E
188.43'

SEC. COR.
STONE
5
4

S.C.C.C.
FEE

THE SUNDAY CREEK COAL CO.
FEE

5.502 ACRE SURVEY

SITUATE IN THE STATE OF OHIO, HOCKING COUNTY,
WARD TOWNSHIP, NORTH HALF OF SECTION 11, T13N, R15W
BEING PART OF DEED TRACT 9 CONVEYED TO
THE SUNDAY CREEK COAL COMPANY RECORDED IN D.B. 51, PG. 328 OF
THE HOCKING COUNTY RECORDER'S OFFICE

BEARINGS ARE NAD 83(CORS)
OHIO STATE PLANE, SOUTH ZONE, GRID
BASED ON GPS OBSERVATIONS.
REFERENCE NGS CORS STATION OHHO
HAVING A LATITUDE OF 39°32'07.27648" N
AND LONGITUDE OF 82°26'37.87659" W
REFERENCE THE EAST LINE OF SECTION 11
AS BEING S 03° 44' 32" W.

PROJECT COMBINED SCALE FACTOR: 0.99990140
ALL DISTANCES ARE GROUND. TO OBTAIN GRID
DISTANCES MULTIPLY EACH DISTANCE BY 0.99990140

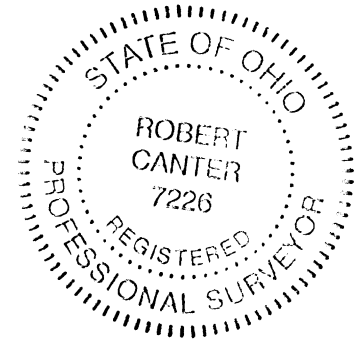
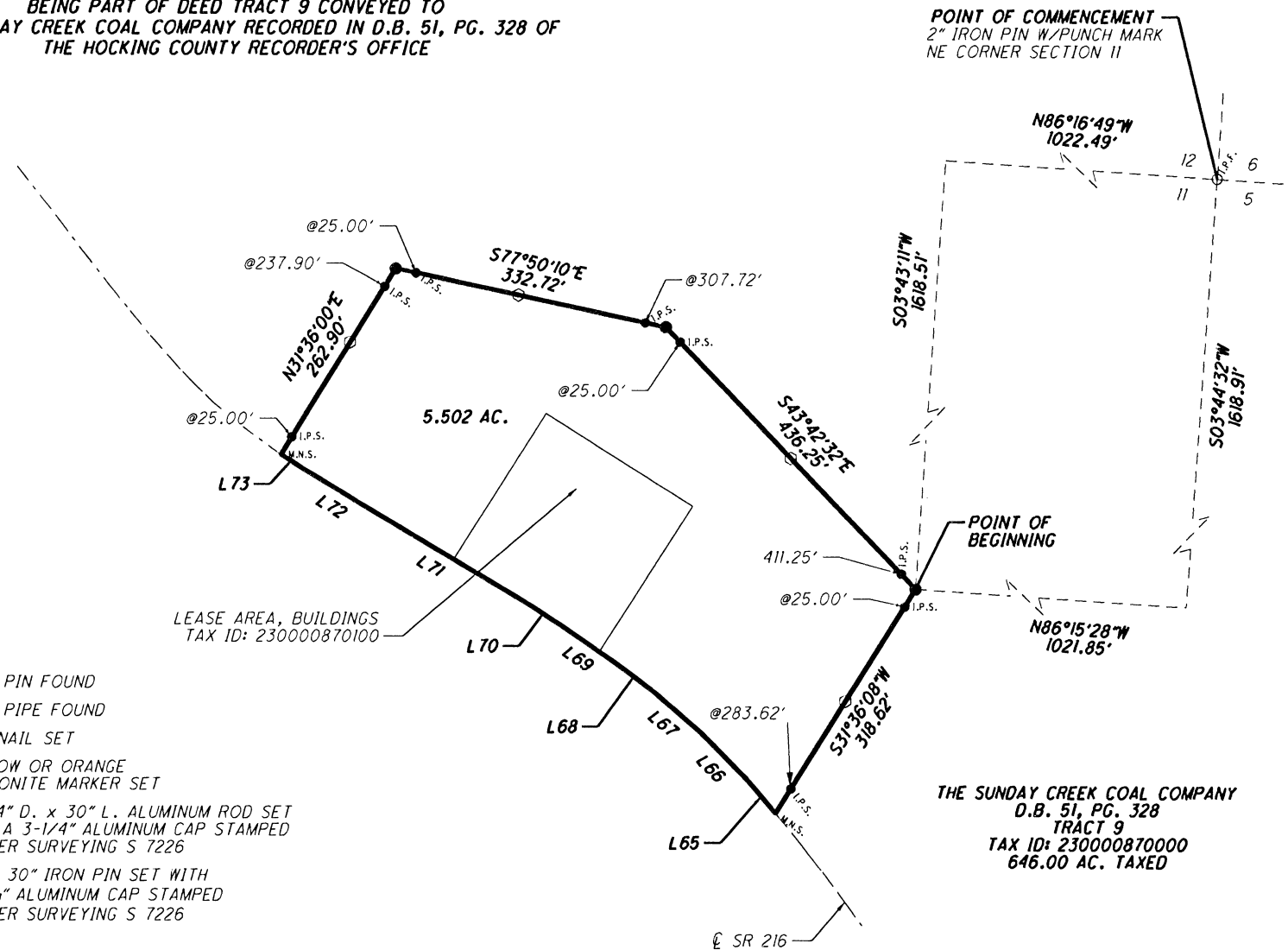

L65	N 40° 41' 15" W	53.06'
L66	N 43° 59' 59" W	78.64'
L67	N 49° 18' 36" W	79.99'
L68	N 52° 59' 43" W	53.06'
L69	N 55° 23' 01" W	80.85'
L70	N 56° 54' 02" W	52.07'
L71	N 59° 12' 46" W	236.98'
L72	N 58° 40' 47" W	78.14'
L73	N 57° 32' 38" W	29.33'

THE SUNDAY CREEK COAL COMPANY
D.B. 51, PG. 328
TRACT 9
TAX ID: 230000870000
646.00 AC. TAXED

APPROVED MATHEMATICALLY
Hocking County Engineer's Office
By: CW Date: M 12 D 3 Y 2012

SURVEYED FEBRUARY 2012 TO JULY 2012 UNDER THE
DIRECTION OF ROBERT C. CANTER, P.S. 7226. SUBJECT
TO ALL LEGAL EASEMENTS, LEASES AND RIGHTS OF WAY.

Robert C. Canter 12-3-12

ROBERT C. CANTER, PS 7226 DATE

- I.P.F. IRON PIN FOUND
- ⊙ P.F. IRON PIPE FOUND
- M.N.S. MAG NAIL SET
- YELLOW OR ORANGE CARSONITE MARKER SET
- 2-3/4" D. x 30" L. ALUMINUM ROD SET WITH A 3-1/4" ALUMINUM CAP STAMPED CANTER SURVEYING S 7226
- I.P.S. 3/4" x 30" IRON PIN SET WITH A 3-1/4" ALUMINUM CAP STAMPED CANTER SURVEYING S 7226

6801 SR 56
ATHENS, OHIO 45701
740-592-5706



12016 5.502 AC SPLIT.DGN

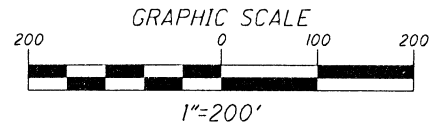

Exhibit A
5.502 Acre Survey

Situate in the State of Ohio, Hocking County, Ward Township, north half of Section 11, T13N, R15W and being part of deed tract 9 conveyed to The Sunday Creek Coal Company recorded in D.B. 51, Pg. 328 of the Hocking County Recorder's office and being more particularly described as follows:

Commencing at a 2" iron pin found with a punch mark at the northeast corner of Section 11, thence S 03° 44' 32" W 1618.91 feet along the east line of Section 11 to a point, thence N 86° 15' 28" W 1021.85 feet across the grantor to an aluminum monument set, said aluminum monument set being the **Point of Beginning** for the parcel herein described;

Thence from the **Point of Beginning** S 31° 36' 08" W 318.62 feet across the grantor to a mag mail set in the center of SR 216 passing an iron pin set a 25.00 feet and at 283.62 feet;

Thence along the center of SR 216 the following nine courses;

1. N 40° 41' 15" W 53.06 feet to a point;
2. N 43° 59' 59" W 78.64 feet to a point;
3. N 49° 18' 36" W 79.99 feet to a point;
4. N 52° 59' 43" W 53.06 feet to a point;
5. N 55° 23' 01" W 80.85 feet to a point;
6. N 56° 54' 02" W 52.07 feet to a point;
7. N 59° 12' 46" W 236.98 feet to a point;
8. N 58° 40' 47" W 78.14 feet to a point;

9. N 57° 32' 38" W 29.33 feet to a mag nail set;

Thence N 31° 36' 00" E 262.90 feet across the grantor to an aluminum monument set passing an iron pin set at 25.00 feet and at 237.90 feet;

Thence S 77° 50' 10" E 332.72 feet across the grantor to an aluminum monument set passing an iron pin set at 25.00 feet and at 307.72 feet;

Thence S 43° 42' 32" E 436.25 feet across the grantor to the **Point of Beginning** passing an iron pin set at 25.00 feet and at 411.25 feet;

The above described contains 5.502 acres more or less and is contained in Auditor's Permanent Parcel Number 230000870000 which presently shows 646.00 acres and all of Auditor's Permanent Parcel Number 230000870100 which presently is for buildings on leased property.

Subject to all legal easements, leases and rights of way.

All iron pins set are 3/4"D x 30"L rebar with a 3-1/4" aluminum cap stamped Canter Surveying S 7226 referenced with a carsonite marker.

All aluminum monuments set are 2-3/4"D x 30"L with a 3-1/4" aluminum cap stamped Canter Surveying S 7226 referenced with a carsonite marker.

This description was prepared under the direction and supervision of Robert C. Canter, Registered Surveyor No. 7226 and is based on a field survey made by Canter Surveying/GPS Services, Inc., completed July 2012.

Prior Instrument Reference: D.B. 51, Pg. 328 of the Hocking County Recorder's Office.

Bearings are NAD 83(CORS), Ohio State Plane, South Zone Grid. Based on GPS observations. Reference NGS CORS station OHHO having a Latitude of 39° 32' 07.27648" N and a Longitude of 82° 26' 37.87659" W. Reference the east line of Section 11 as being S 03° 44' 32" W.

Robert C. Canter, P.S. 7226

12-3-12
Date

APPROVED MATHEMATICALLY
Hocking County Engineer's Office
By: CW Date: M. 12 D. 3 Y. 2012

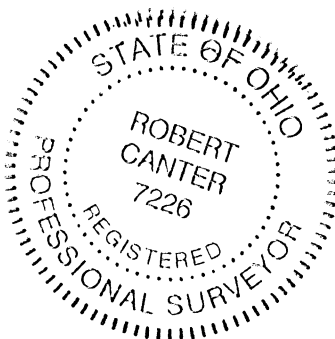

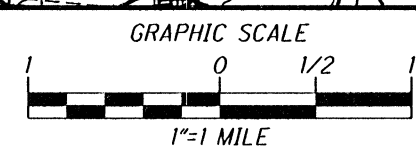
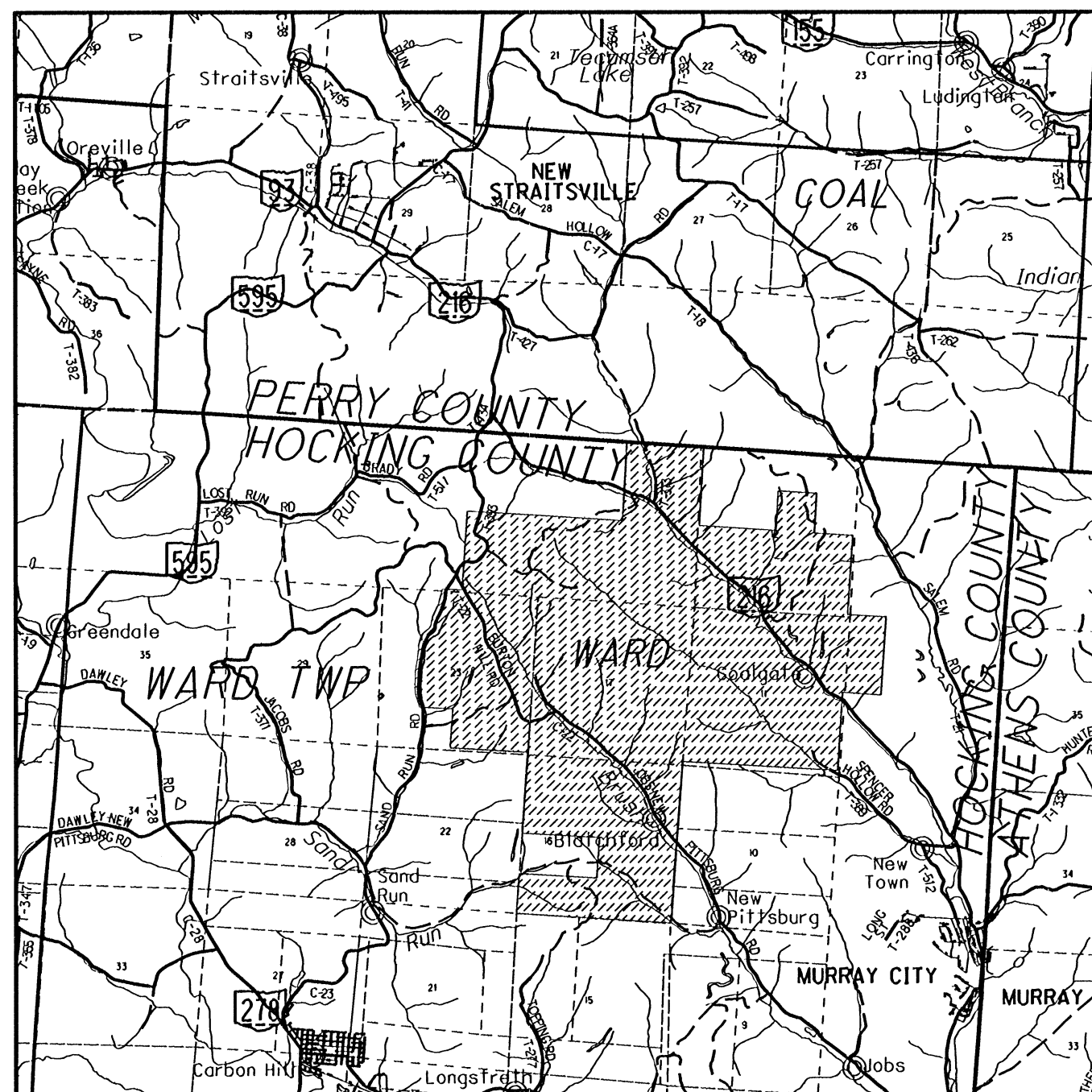

LAT: 39° 32' 09" N
LONG: 82° 11' 52" W

3331.878 ACRE BOUNDARY SURVEY FOR THE OHIO DEPARTMENT OF TRANSPORTATION
SITUATE IN THE STATE OF OHIO, HOCKING COUNTY,
WARD TOWNSHIP, SECTIONS 5, 11, 12, 16, 17, 18, 23 & 24, T13N, R15W
BEING THE SAME AS DEED TRACT 4, 9, 10, 13, 14, 15, 19 AND PART OF 18
CONVEYED TO THE SUNDAY CREEK COAL COMPANY RECORDED IN D.B. 51, PG. 328 OF
THE HOCKING COUNTY RECORDER'S OFFICE

BEARINGS ARE NAD 83(CORS)
OHIO STATE PLANE, SOUTH ZONE, GRID
BASED ON GPS OBSERVATIONS.
REFERENCE NGS CORS STATION OHHO
HAVING A LATITUDE OF 39°32'07.27648" N
AND LONGITUDE OF 82°26'37.87659" W
REFERENCE THE WEST LINE OF SECTION
16 AS BEING N04°03'00"E.

PROJECT COMBINED SCALE FACTOR: 0.99990140
ALL DISTANCES ARE GROUND. TO OBTAIN GRID
DISTANCES MULTIPLY EACH DISTANCE BY 0.99990140

SCHEMATIC LAYOUT OF SHEETS

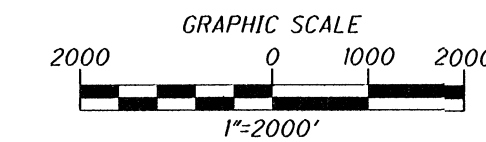
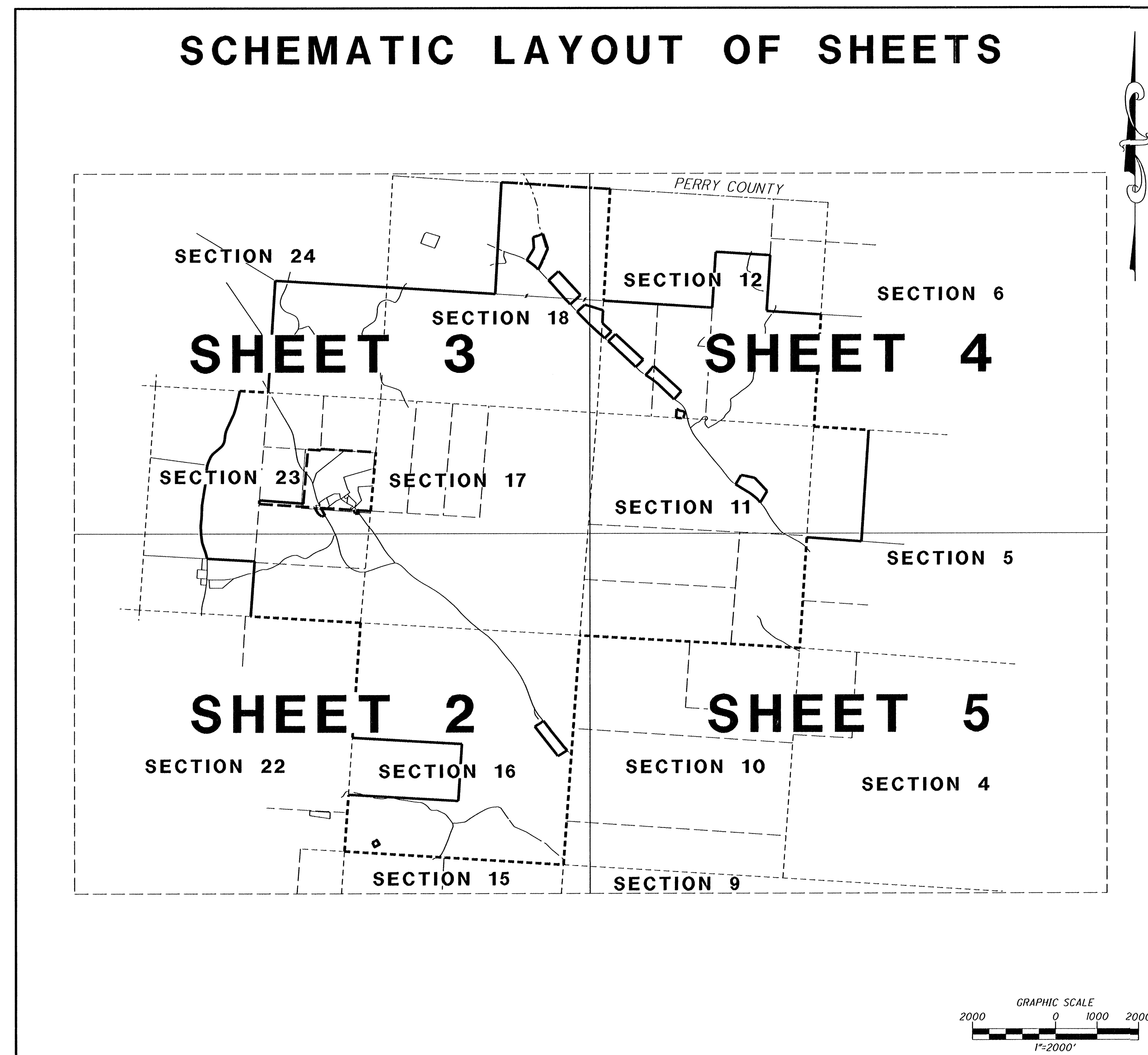

TOTAL 3331.878 ACRES

- 80.837 AC. IN SECTION 5
- 641.768 AC. IN SECTION 11
- 353.172 AC. IN SECTION 12
- 582.099 AC. IN SECTION 16
- 651.219 AC. IN SECTION 17
- 469.735 AC. IN SECTION 18
- 385.565 AC. IN SECTION 23
- 167.483 AC. IN SECTION 24

REFERENCES

- DEEDS AS NOTED
- COUNTY TAX MAPS
- COUNTY GIS
- 1880's PLATS
- SURVEY BY:
- SURVEYS DONATED BY ALBERT W. SEABRIGHT (SECTION 5)
- JOHN M. BRANNER 3 PARCELS DATED APRIL 2009 (SECTION 6)
- SEYMOUR & ASSOCIATES 83.668 AC. DATED MARCH 2000 (SECTION 16)
- SURVEY DONATED BY ALBERT W. SEABRIGHT (SECTION 18)
- CERTIFIED LAND CORNER RESTORATION (SECTION 18)
- A.O.G. SURVEYING, 3 PARCELS DATED DECEMBER 2007 (SECTION 23)
- JOSEPH C. ROMAN 144.60 AC. DATED APRIL & MAY 2005 (SECTION 23)
- SEYMOUR & ASSOCIATES, 2 PARCELS DATED JANUARY 2006 (SECTION 23)
- SEYMOUR & ASSOCIATES 39.9819 AC. DATED MARCH 2006 (SECTION 23)
- CERTIFIED LAND CORNER RESTORATION (SECTION 23)
- CERTIFIED LAND CORNER RESTORATION (SECTION 24)
- U.S. FOREST SERVICE SURVEY (HOCKING & PERRY COUNTY LINE)

LEGEND

- ✱ RAILROAD SPIKE SET
- ⋈ MINE RAIL FOUND
- I.P.F. IRON PIN FOUND
- ⊙ I.P.F. IRON PIPE FOUND
- ⊗ AXLE AXLE FOUND
- STONE FOUND
- ☁ TREE
- ⊕ STUMP
- YELLOW OR ORANGE CARSONITE MARKER SET
- M.N.S. MAG NAIL SET
- 2-3/4" D. x 30" L. ALUMINUM ROD SET WITH A 3-1/4" ALUMINUM CAP STAMPED CANTER SURVEYING S 7226
- I.P.S. 3/4" x 30" IRON PIN SET WITH A 3-1/4" ALUMINUM CAP STAMPED CANTER SURVEYING S 7226
- x- FENCE
- - - SECTION LINE
- - - LOT LINE
- - - COUNTY LINE

INDEX OF SHEETS

TITLE SHEET	1
BOUNDARY SURVEY	2-5
EXCEPTIONS	6-7

APPROVED MATHEMATICALLY
Hocking County Engineer's Office
By: *OC* Date: M.12.13. 3. 2012

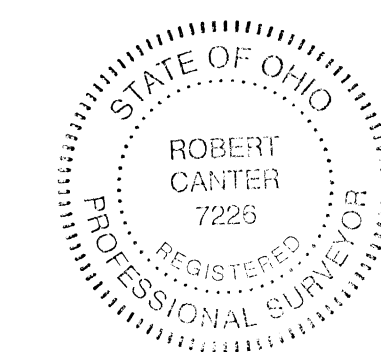

SURVEYED FEBRUARY 2012 TO JULY 2012 UNDER THE DIRECTION OF ROBERT C. CANTER, P.S. 7226. SUBJECT TO ALL LEGAL EASEMENTS, LEASES AND RIGHTS OF WAY.

Robert C. Canter 12-2-12
ROBERT C. CANTER, PS 7226 DATE

6801 SR 56
ATHENS, OHIO 45701
740-592-5706



12016 TITLE.DGN

PID NO.
79577

R/W DESIGNER
R/W REVIEWER

TITLE SHEET

HOC / ATH - 33 -
16.52 / 0.00

1
7

SITUATE IN THE STATE OF OHIO, HOCKING COUNTY,
 WARD TOWNSHIP, SECTIONS 5, 11, 12, 16, 17, 18, 23 & 24, T13N, R15W
 BEING THE SAME AS DEED TRACT 4, 9, 10, 13, 14, 15, 19 AND PART OF 18
 CONVEYED TO THE SUNDAY CREEK COAL COMPANY RECORDED IN D.B. 51, PG. 328 OF
 THE HOCKING COUNTY RECORDER'S OFFICE

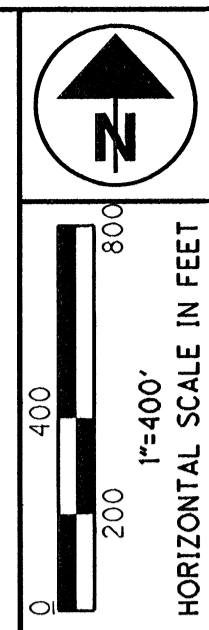

PID NO.
79577

R/W DESIGNER
 R/W REVIEWER

BOUNDARY SURVEY

**HOC / ATH - 33 -
 16.52 / 0.00**

2
 7

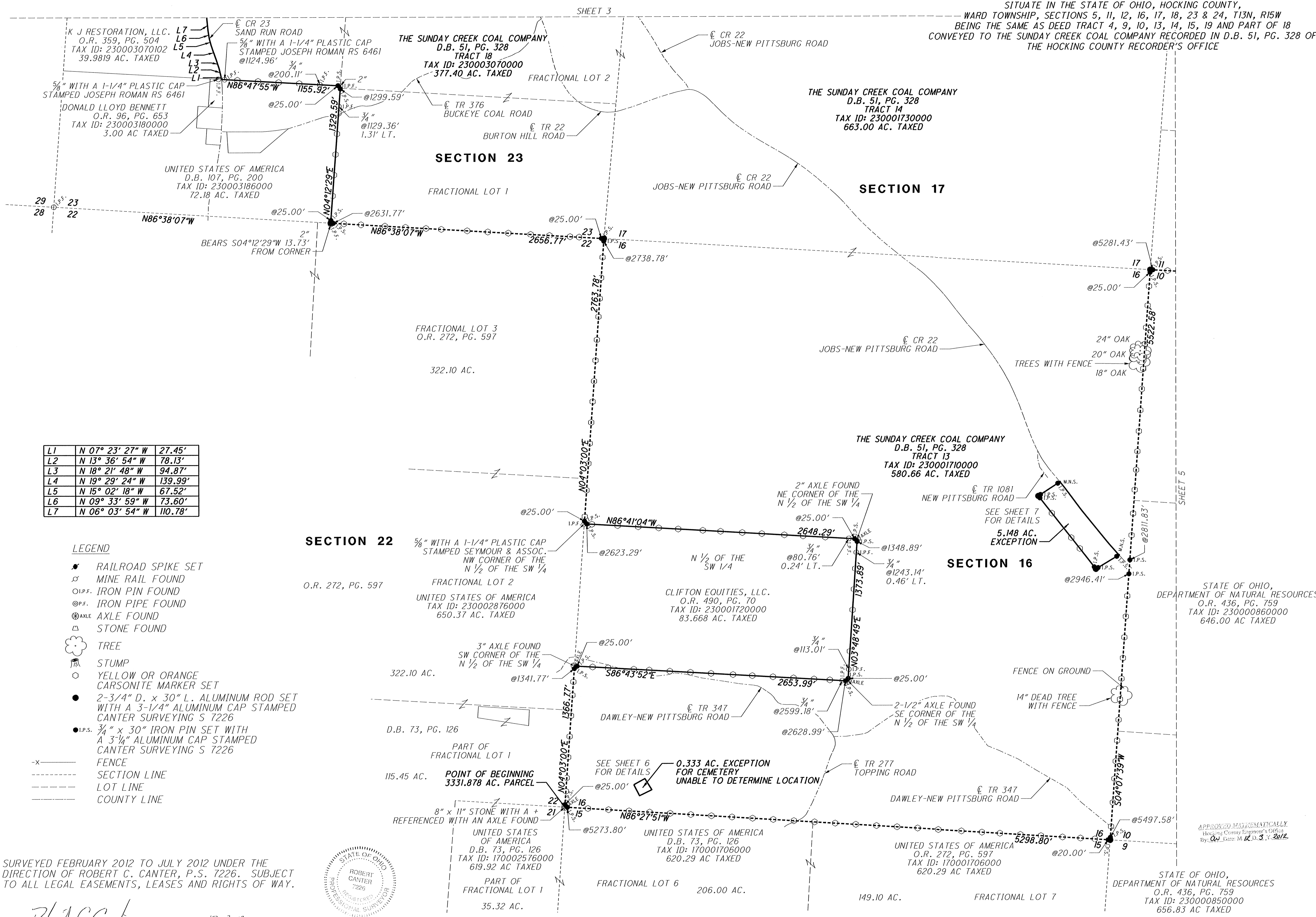

L1	N 07° 23' 27" W	27.45'
L2	N 13° 36' 54" W	78.13'
L3	N 18° 21' 48" W	94.87'
L4	N 19° 29' 24" W	139.99'
L5	N 15° 02' 18" W	67.52'
L6	N 09° 33' 59" W	73.60'
L7	N 06° 03' 54" W	110.78'

LEGEND

- RAILROAD SPIKE SET
- ⊙ MINE RAIL FOUND
- I.P.F. IRON PIN FOUND
- ⊙ I.P.F. IRON PIPE FOUND
- ⊙ AXLE AXLE FOUND
- ⊙ STONE FOUND
- ☁ TREE
- ⊙ STUMP
- YELLOW OR ORANGE CARSONITE MARKER SET
- 2-3/4" D. x 30" L. ALUMINUM ROD SET WITH A 3-1/4" ALUMINUM CAP STAMPED CANTER SURVEYING S 7226
- I.P.S. 3/4" x 30" IRON PIN SET WITH A 3-1/4" ALUMINUM CAP STAMPED CANTER SURVEYING S 7226
- x- FENCE
- - - SECTION LINE
- - - LOT LINE
- - - COUNTY LINE

SURVEYED FEBRUARY 2012 TO JULY 2012 UNDER THE DIRECTION OF ROBERT C. CANTER, P.S. 7226. SUBJECT TO ALL LEGAL EASEMENTS, LEASES AND RIGHTS OF WAY.

Robert C. Canter
 ROBERT C. CANTER, PS 7226
 12-3-12
 DATE

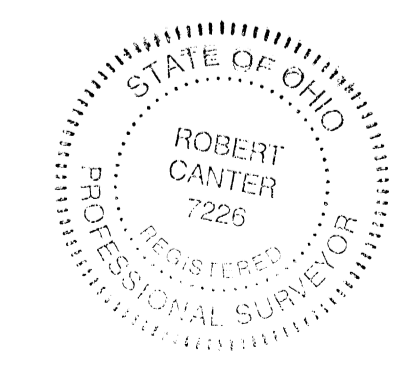

APPROVED MATHEMATICALLY
 Hocking County Engineer's Office
 By: *Clayton M. R. D. S. V. 2012*

STATE OF OHIO,
 DEPARTMENT OF NATURAL RESOURCES
 O.R. 436, PG. 759
 TAX ID: 230000860000
 646.00 AC TAXED

STATE OF OHIO,
 DEPARTMENT OF NATURAL RESOURCES
 O.R. 436, PG. 759
 TAX ID: 230000850000
 656.83 AC TAXED

STATE OF OHIO,
 DEPARTMENT OF NATURAL RESOURCES
 O.R. 436, PG. 759
 TAX ID: 230001706000
 620.29 AC TAXED

STATE OF OHIO,
 DEPARTMENT OF NATURAL RESOURCES
 O.R. 436, PG. 759
 TAX ID: 230001706000
 620.29 AC TAXED

STATE OF OHIO,
 DEPARTMENT OF NATURAL RESOURCES
 O.R. 436, PG. 759
 TAX ID: 230002876000
 650.37 AC TAXED

STATE OF OHIO,
 DEPARTMENT OF NATURAL RESOURCES
 O.R. 436, PG. 759
 TAX ID: 230003186000
 72.18 AC TAXED

STATE OF OHIO,
 DEPARTMENT OF NATURAL RESOURCES
 O.R. 436, PG. 759
 TAX ID: 230003180000
 3.00 AC TAXED

STATE OF OHIO,
 DEPARTMENT OF NATURAL RESOURCES
 O.R. 436, PG. 759
 TAX ID: 230003070102
 39.9819 AC TAXED

STATE OF OHIO,
 DEPARTMENT OF NATURAL RESOURCES
 O.R. 436, PG. 759
 TAX ID: 230003070000
 377.40 AC TAXED

STATE OF OHIO,
 DEPARTMENT OF NATURAL RESOURCES
 O.R. 436, PG. 759
 TAX ID: 230001730000
 663.00 AC TAXED

STATE OF OHIO,
 DEPARTMENT OF NATURAL RESOURCES
 O.R. 436, PG. 759
 TAX ID: 230001710000
 580.66 AC TAXED

STATE OF OHIO,
 DEPARTMENT OF NATURAL RESOURCES
 O.R. 436, PG. 759
 TAX ID: 230001720000
 83.668 AC TAXED

STATE OF OHIO,
 DEPARTMENT OF NATURAL RESOURCES
 O.R. 436, PG. 759
 TAX ID: 170001706000
 620.29 AC TAXED

STATE OF OHIO,
 DEPARTMENT OF NATURAL RESOURCES
 O.R. 436, PG. 759
 TAX ID: 170002576000
 619.92 AC TAXED

STATE OF OHIO,
 DEPARTMENT OF NATURAL RESOURCES
 O.R. 436, PG. 759
 TAX ID: 170001706000
 620.29 AC TAXED

STATE OF OHIO,
 DEPARTMENT OF NATURAL RESOURCES
 O.R. 436, PG. 759
 TAX ID: 170001706000
 620.29 AC TAXED

L8	N 02° 50' 13" W	133.44'
L9	N 00° 29' 06" E	109.20'
L10	N 05° 06' 14" E	164.24'
L11	N 05° 39' 06" E	54.48'
L12	N 01° 08' 41" E	211.15'
L13	N 05° 43' 25" E	46.66'
L14	N 08° 52' 35" E	269.37'
L15	N 09° 21' 11" E	225.00'
L16	N 06° 46' 29" E	143.25'
L17	N 04° 05' 01" E	200.37'
L18	N 08° 36' 09" E	77.45'
L19	N 13° 04' 43" E	73.77'
L20	N 18° 23' 29" E	78.07'
L21	N 23° 47' 55" E	72.10'
L22	N 27° 45' 41" E	35.65'
L23	N 30° 57' 20" E	28.38'
L24	N 34° 18' 28" E	26.38'
L25	N 42° 09' 18" E	56.15'
L26	N 48° 03' 36" E	28.09'
L27	N 51° 04' 16" E	173.17'
L28	N 46° 02' 52" E	71.34'
L29	N 39° 30' 58" E	25.72'
L30	N 34° 57' 25" E	26.77'
L31	N 25° 28' 27" E	26.70'
L32	N 18° 45' 07" E	29.82'
L33	N 14° 38' 27" E	26.24'
L34	N 07° 04' 42" E	142.49'
L35	N 11° 49' 15" E	57.46'
L36	N 16° 44' 48" E	56.40'
L37	N 20° 16' 02" E	25.28'
L38	N 23° 20' 54" E	57.15'
L39	N 25° 26' 29" E	334.87'
L40	N 21° 59' 17" E	28.01'
L41	N 18° 55' 12" E	83.48'
L42	N 16° 27' 41" E	53.99'
L43	N 14° 14' 53" E	308.74'
L44	N 11° 47' 32" E	119.71'

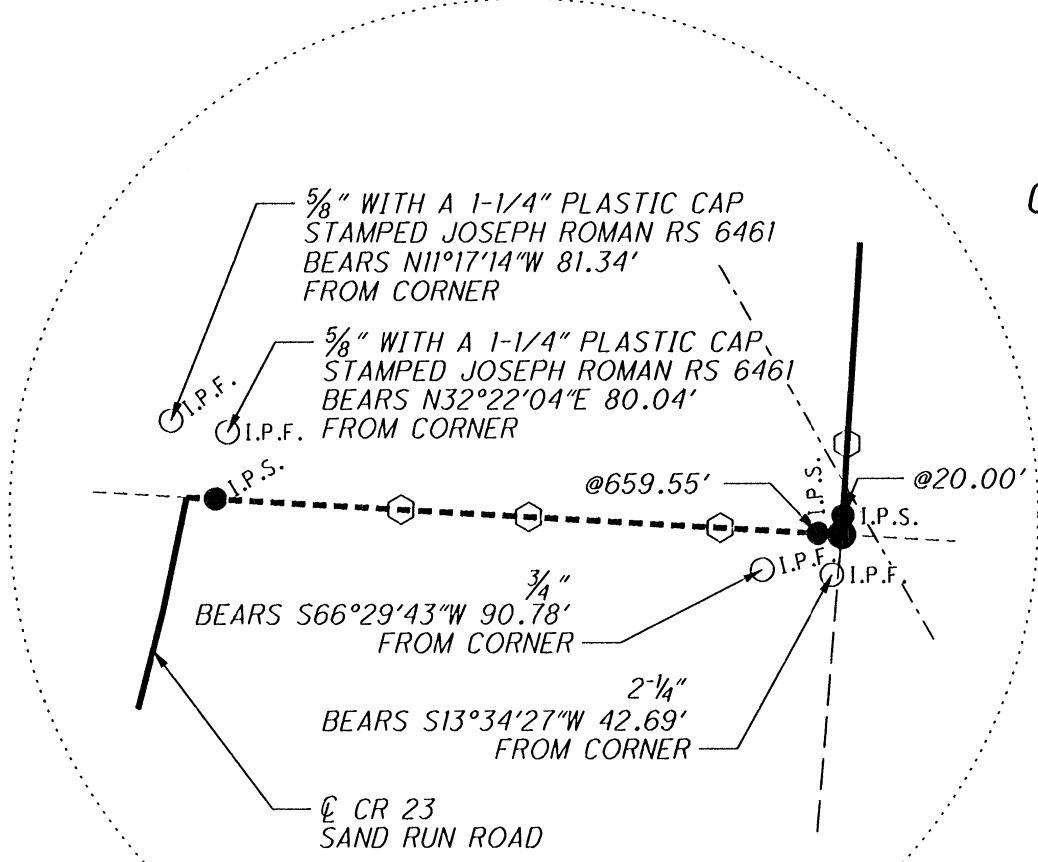

SITUATE IN THE STATE OF OHIO, HOCKING COUNTY,
WARD TOWNSHIP, SECTIONS 5, 11, 12, 16, 17, 18, 23 & 24, T13N, R15W
BEING THE SAME AS DEED TRACT 4, 9, 10, 13, 14, 15, 19 AND PART OF 18
CONVEYED TO THE SUNDAY CREEK COAL COMPANY RECORDED IN D.B. 51, PG. 328 OF
THE HOCKING COUNTY RECORDER'S OFFICE

UNITED STATES OF AMERICA
O.R. 230, PG. 694
TAX ID: 230003216000, 43.20 AC TAXED

UNITED STATES OF AMERICA
D.B. 72, PG. 206
TAX ID: 230003216000, 505.57 AC. TAXED

UNITED STATES OF AMERICA
D.B. 72, PG. 206
TAX ID: 230001746000, 162.12 AC TAXED

THE SUNDAY CREEK COAL COMPANY
D.B. 51, PG. 328
TRACT 19
TAX ID: 230003220000
165.00 AC. TAXED

THE SUNDAY CREEK COAL COMPANY
D.B. 51, PG. 328
TRACT 15
TAX ID: 230001750000
483.02 AC. TAXED

UNITED STATES OF AMERICA
D.B. 72, PG. 206
TAX ID: 230003216000, 505.57 AC TAXED

LARRY A. LONG AND
PAMELA S. LONG
O.R. 357, PG. 89
TAX ID: 230003070101
72.2954 AC. TAXED

ROBERT T. THELLER AND
REBECCA L. THELLER
O.R. 361, PG. 124
TAX ID: 230003070100
32.3303 AC. TAXED

THE SUNDAY CREEK COAL COMPANY
D.B. 51, PG. 328
TRACT 18
TAX ID: 230003070000
377.40 AC. TAXED

THE SUNDAY CREEK COAL COMPANY
D.B. 51, PG. 328
TRACT 14
TAX ID: 230001730000
663.00 AC. TAXED

LEGEND

- RAILROAD SPIKE SET
- ⊕ MINE RAIL FOUND
- I.P.F. IRON PIN FOUND
- ⊙ I.P.F. IRON PIPE FOUND
- ⊗ AXLE FOUND
- △ STONE FOUND
- ☼ TREE
- ⊕ STUMP
- YELLOW OR ORANGE CARSONITE MARKER SET
- 2-3/4" D. x 30" L. ALUMINUM ROD SET WITH A 3-1/4" ALUMINUM CAP STAMPED CANTER SURVEYING S 7226
- I.P.S. 3/4" x 30" IRON PIN SET WITH A 3-1/4" ALUMINUM CAP STAMPED CANTER SURVEYING S 7226
- x- FENCE
- - - SECTION LINE
- - - - - LOT LINE
- - - - - COUNTY LINE

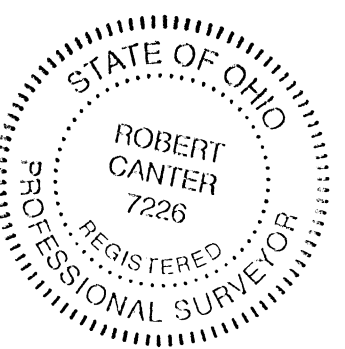

SURVEYED FEBRUARY 2012 TO JULY 2012 UNDER THE DIRECTION OF ROBERT C. CANTER, P.S. 7226. SUBJECT TO ALL LEGAL EASEMENTS, LEASES AND RIGHTS OF WAY.

ROBERT C. CANTER, PS 7226
DATE 12-3-12

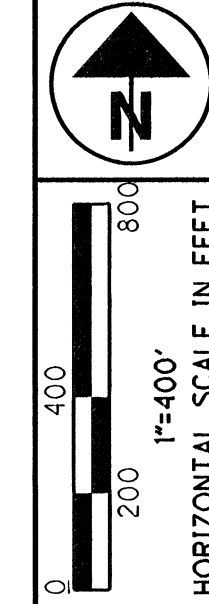

PID NO. 79577

R/W DESIGNER
R/W REVIEWER

BOUNDARY SURVEY

HOC/ATH-33-16.52/0.00

3/7

APPROVED MATHEMATICALLY
By: CJC Date: 4/23/2012

SHEET 2

SHEET 4

SITUATE IN THE STATE OF OHIO, HOCKING COUNTY,
 WARD TOWNSHIP, SECTIONS 5, 11, 12, 16, 17, 18, 23 & 24, T13N, R15W
 BEING THE SAME AS DEED TRACT 4, 9, 10, 13, 14, 15, 19 AND PART OF 18
 CONVEYED TO THE SUNDAY CREEK COAL COMPANY RECORDED IN D.B. 51, PG. 328 OF
 THE HOCKING COUNTY RECORDER'S OFFICE

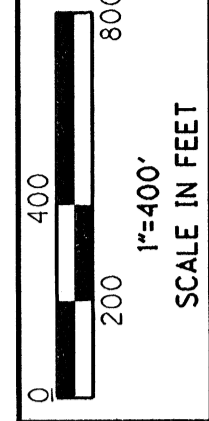
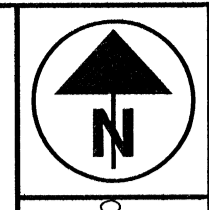

PID NO.
79577

R/W DESIGNER
 R/W REVIEWER

BOUNDARY SURVEY

**HOC/ATH-33-
 16.52/0.00**

4
 7

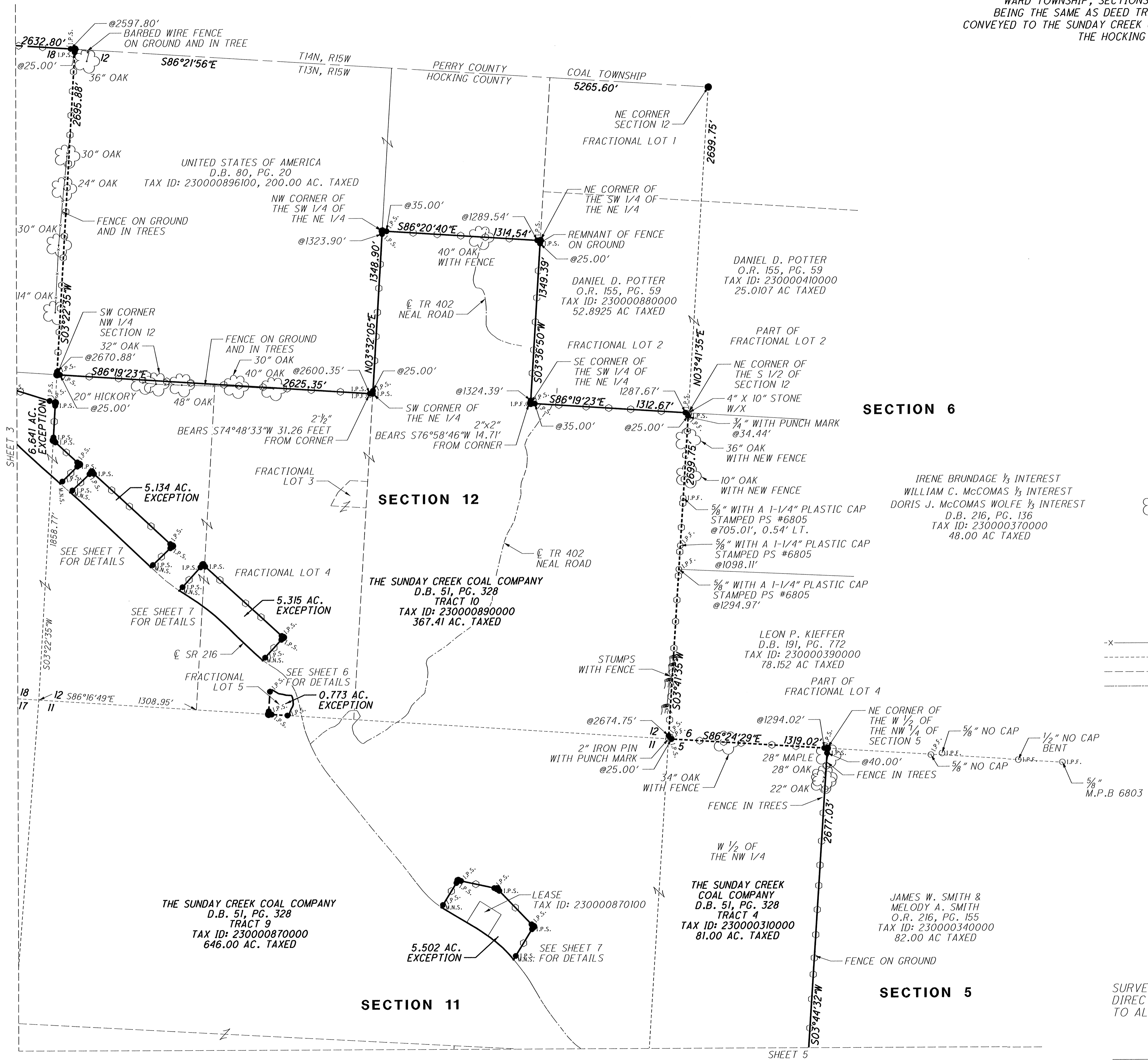

LEGEND

- RAILROAD SPIKE SET
- ⊕ MINE RAIL FOUND
- I.P.F. IRON PIN FOUND
- ⊙ P.F. IRON PIPE FOUND
- ⊗ AXLE AXLE FOUND
- ⊠ STONE FOUND
- ☁ TREE
- ⊔ STUMP
- YELLOW OR ORANGE CARSONITE MARKER SET
- 2-3/4" D. x 30" L. ALUMINUM ROD SET WITH A 3-1/4" ALUMINUM CAP STAMPED CANTER SURVEYING S 7226
- I.P.S. 3/4" x 30" IRON PIN SET WITH A 3-1/4" ALUMINUM CAP STAMPED CANTER SURVEYING S 7226
- x- FENCE
- - - SECTION LINE
- - - - - LOT LINE
- - - - - COUNTY LINE

APPROVED MECHANICALLY
 Hocking County Engineer's Office
 By: *CW* Date: *4/2/12*



SURVEYED FEBRUARY 2012 TO JULY 2012 UNDER THE
 DIRECTION OF ROBERT C. CANTER, P.S. 7226. SUBJECT
 TO ALL LEGAL EASEMENTS, LEASES AND RIGHTS OF WAY.

Robert C. Canter 12-3-12
 ROBERT C. CANTER, PS 7226 DATE

SHEET 5

SHEET 3

SITUATE IN THE STATE OF OHIO, HOCKING COUNTY,
 WARD TOWNSHIP, SECTIONS 5, 11, 12, 16, 17, 18, 23 & 24, T13N, R15W
 BEING THE SAME AS DEED TRACT 4, 9, 10, 13, 14, 15, 19 AND PART OF 18
 CONVEYED TO THE SUNDAY CREEK COAL COMPANY RECORDED IN D.B. 51, PG. 328 OF
 THE HOCKING COUNTY RECORDER'S OFFICE

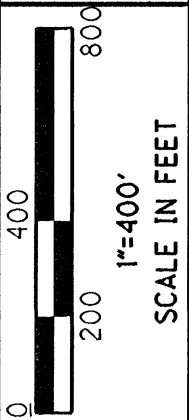

PID NO.
79577

R/W DESIGNER
 R/W REVIEWER

BOUNDARY SURVEY

**HOC / ATH - 33 -
 16.52 / 0.00**

5
 7

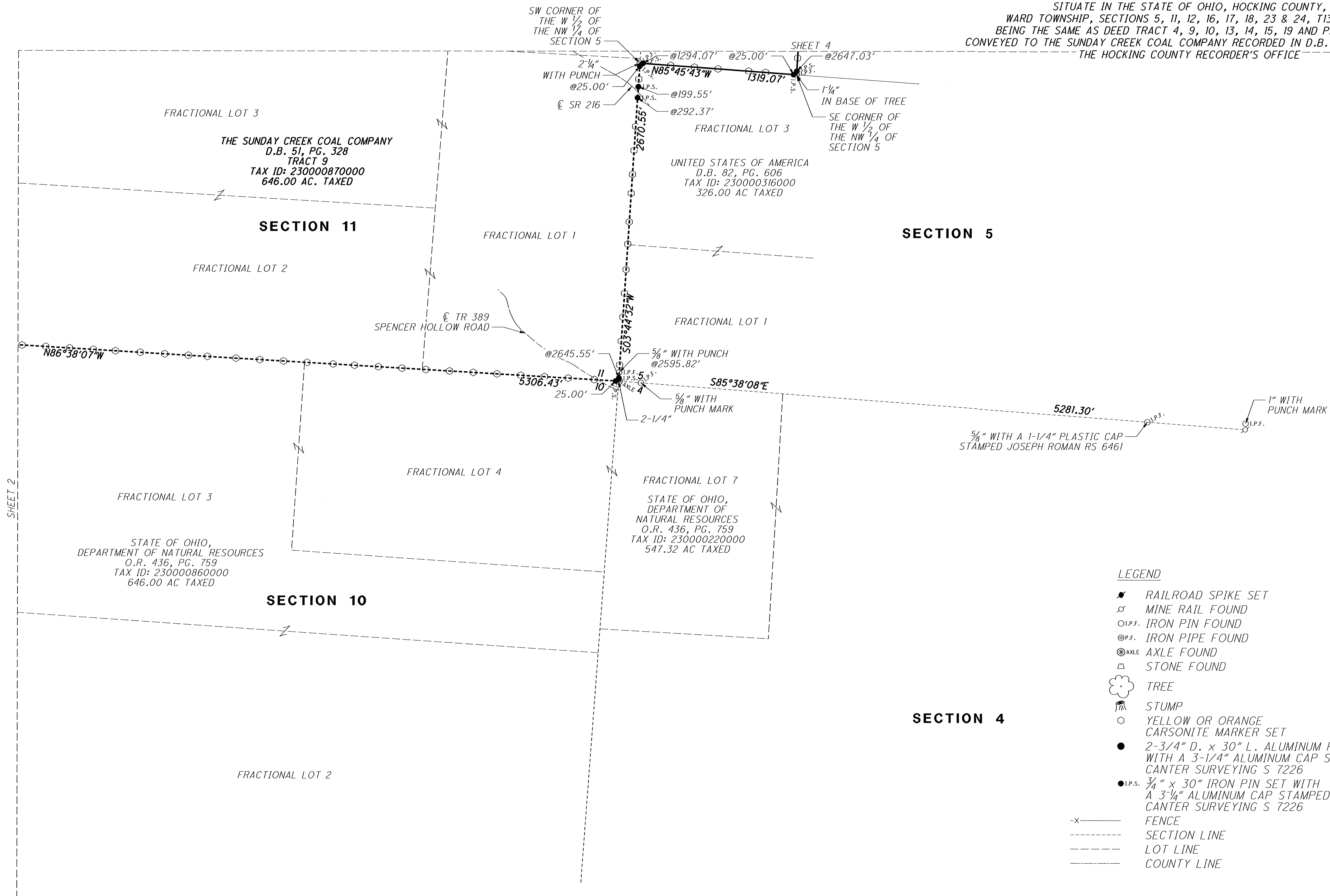

- LEGEND**
- ✱ RAILROAD SPIKE SET
 - ⊕ MINE RAIL FOUND
 - I.P.F. IRON PIN FOUND
 - ⊙ P.F. IRON PIPE FOUND
 - ⊗ AXLE FOUND
 - STONE FOUND
 - ☼ TREE
 - ♣ STUMP
 - YELLOW OR ORANGE CARSONITE MARKER SET
 - 2-3/4" D. x 30" L. ALUMINUM ROD SET WITH A 3-1/4" ALUMINUM CAP STAMPED CANTER SURVEYING S 7226
 - I.P.S. 3/4" x 30" IRON PIN SET WITH A 3-1/4" ALUMINUM CAP STAMPED CANTER SURVEYING S 7226
 - x- FENCE
 - - - SECTION LINE
 - - - LOT LINE
 - - - COUNTY LINE

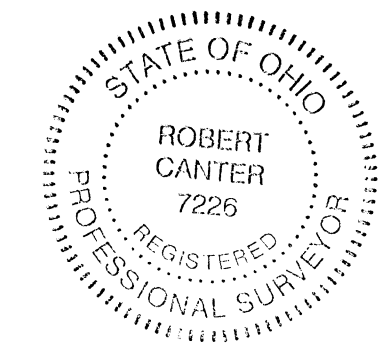

APPROVED MATHEMATICALLY
 Hocking County Engineer's Office
 By: CW, Date: M. 12, D. 3, Y. 2012

SURVEYED FEBRUARY 2012 TO JULY 2012 UNDER THE
 DIRECTION OF ROBERT C. CANTER, P.S. 7226. SUBJECT
 TO ALL LEGAL EASEMENTS, LEASES AND RIGHTS OF WAY.

Robert C. Canter 12-3-12
 ROBERT C. CANTER, PS 7226 DATE

SHEET 2

SHEET 4

FRACTIONAL LOT 3
 THE SUNDAY CREEK COAL COMPANY
 D.B. 51, PG. 328
 TRACT 9
 TAX ID: 230000870000
 646.00 AC. TAXED

FRACTIONAL LOT 3
 UNITED STATES OF AMERICA
 D.B. 82, PG. 606
 TAX ID: 230000316000
 326.00 AC TAXED

SECTION 11

FRACTIONAL LOT 2

FRACTIONAL LOT 1

SECTION 5

FRACTIONAL LOT 1

SPENCER HOLLOW ROAD
 TR 389

FRACTIONAL LOT 4

FRACTIONAL LOT 7
 STATE OF OHIO,
 DEPARTMENT OF
 NATURAL RESOURCES
 O.R. 436, PG. 759
 TAX ID: 230000220000
 547.32 AC TAXED

FRACTIONAL LOT 3
 STATE OF OHIO,
 DEPARTMENT OF NATURAL RESOURCES
 O.R. 436, PG. 759
 TAX ID: 230000860000
 646.00 AC TAXED

SECTION 10

FRACTIONAL LOT 2

SECTION 4

0.333 ACRE EXCEPTION

SITUATE IN THE STATE OF OHIO, HOCKING COUNTY, WARD TOWNSHIP, SOUTH HALF OF THE SOUTHWEST QUARTER OF SECTION 16, T13N, R15W BEING THE SAME EXCEPTION DESCRIBED IN DEED TRACT 13 CONVEYED TO THE SUNDAY CREEK COAL COMPANY RECORDED IN D.B. 51, PG. 328 OF THE HOCKING COUNTY RECORDER'S OFFICE

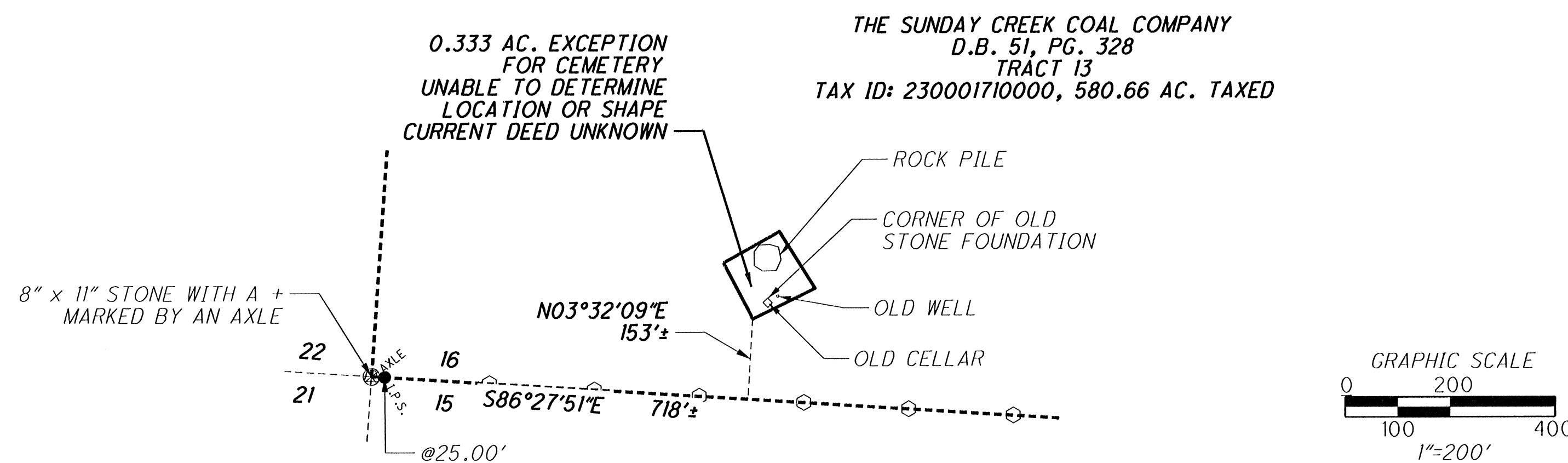

L52	N 03° 43' 11\"/>
L53	S 59° 09' 21\"/>
L54	S 79° 12' 02\"/>
L55	S 77° 31' 06\"/>
L56	S 86° 05' 49\"/>
L57	S 23° 37' 47\"/>
L58	S 09° 07' 41\"/>
L59	S 03° 10' 15\"/>
L60	S 18° 25' 02\"/>
L61	S 30° 54' 09\"/>
L62	S 22° 00' 57\"/>
L63	S 17° 40' 07\"/>
L64	N 86° 16' 49\"/>

0.773 ACRE EXCEPTION

SITUATE IN THE STATE OF OHIO, HOCKING COUNTY, WARD TOWNSHIP, SECTION 12, FRACTIONAL LOT 5, T13N, R15W BEING THE SAME EXCEPTION DESCRIBED IN DEED TRACT 10 CONVEYED TO THE HOCKING COUNTY RECORDER'S OFFICE

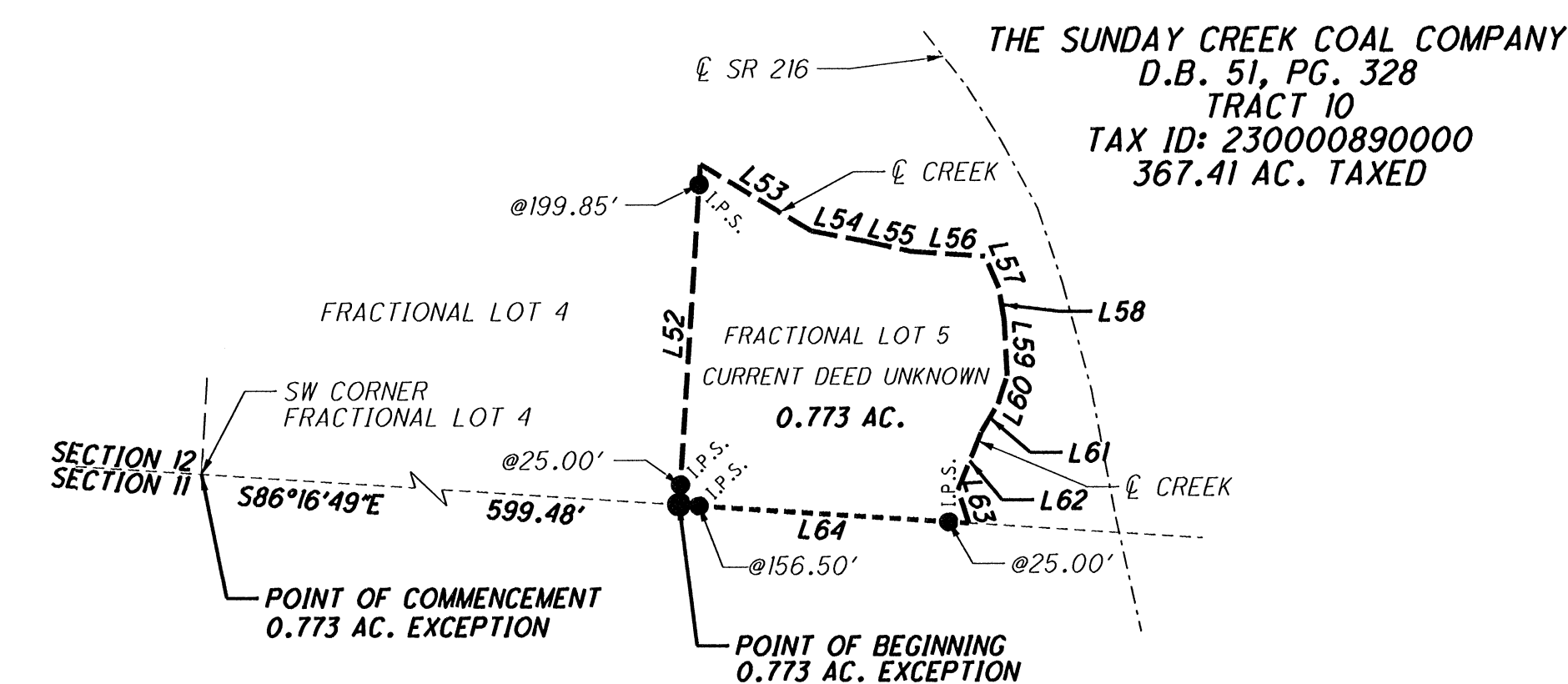

55.708 ACRE EXCEPTION
SITUATE IN THE STATE OF OHIO, HOCKING COUNTY, WARD TOWNSHIP, SECTION 23, FRACTIONAL LOTS 2, 3 AND 4

1 C. SCOTT WALTERS AND JULIE A. WALTERS O.R. 405, PG. 426 PARCEL ID: 230003100300 22.763 AC. TAXED

2 J. ROGER BARBER D.B. 221, PG. 630 PARCEL ID: 230003080000 10.71 AC. TAXED

3 WILLIAM NAFFZIGER AND COLLEEN NAFFZIGER O.R. 410, PG. 103 PARCEL ID: 230003090000 3.54 AC. TAXED

4 BRENT W. WHITNEY D.B. 172, PG. 715 PARCEL ID: 230003150000 0.18 AC. TAXED

5 MARK KINNISON D.B. 217, PG. 119 PARCEL ID: 230003140000 1 AC. TAXED

6 SHYANA BOOKMAN O.R. 469, PG. 684

7 C. SCOTT WALTERS AND JULIE A. WALTERS O.R. 405, PG. 424 PARCEL ID: 230003100200 8.924 AC. TAXED

8 MARK KINNISON D.B. 217, PG. 119 PARCEL ID: 230003130000 0.25 AC. TAXED

THE SUNDAY CREEK COAL COMPANY D.B. 51, PG. 328 TRACT 18 TAX ID: 230003070000 377.40 AC. TAXED

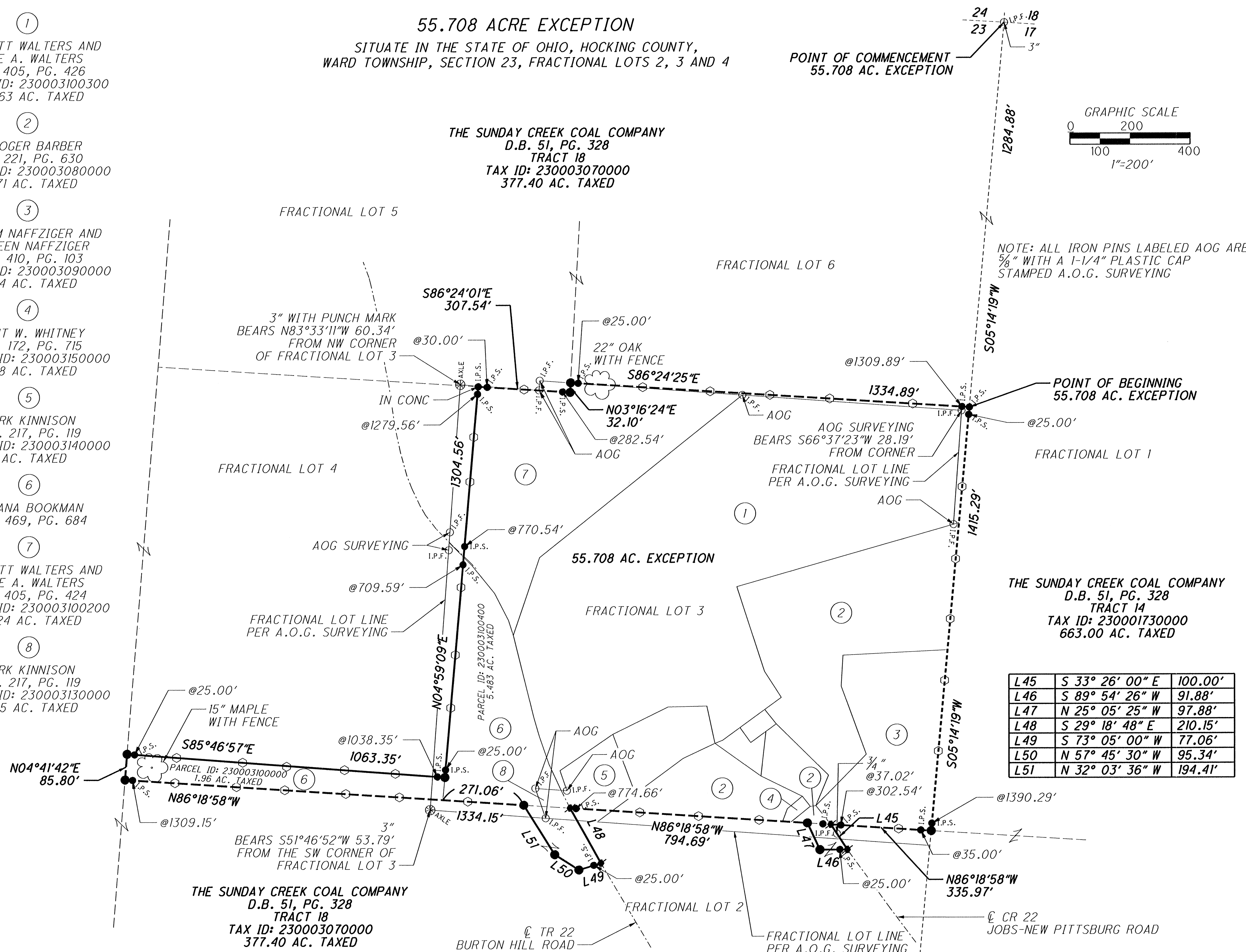

L45	S 33° 26' 00\"/>
L46	S 89° 54' 26\"/>
L47	N 25° 05' 25\"/>
L48	S 29° 18' 48\"/>
L49	S 73° 05' 00\"/>
L50	N 57° 45' 30\"/>
L51	N 32° 03' 36\"/>

LEGEND

- RAILROAD SPIKE SET
- ⋈ MINE RAIL FOUND
- I.P.F. IRON PIN FOUND
- ⊙ I.P.F. IRON PIPE FOUND
- ⊗ AXLE FOUND
- △ STONE FOUND
- ☼ TREE
- ⊖ STUMP
- YELLOW OR ORANGE CARSONITE MARKER SET
- 2-3/4" D. x 30" L. ALUMINUM ROD SET WITH A 3-1/4" ALUMINUM CAP STAMPED CANTER SURVEYING S 7226
- I.P.S. 3/4" x 30" IRON PIN SET WITH A 3-1/4" ALUMINUM CAP STAMPED CANTER SURVEYING S 7226
- x- FENCE
- - - SECTION LINE
- - - LOT LINE
- - - COUNTY LINE



APPROVED AS LEGALLY HOCKING COUNTY ENGINEER'S OFFICE By: CW Date: M. 12.0. 3. 12.2012

SURVEYED FEBRUARY 2012 TO JULY 2012 UNDER THE DIRECTION OF ROBERT C. CANTER, P.S. 7226. SUBJECT TO ALL LEGAL EASEMENTS, LEASES AND RIGHTS OF WAY.

Robert C. Canter 12-3-12
ROBERT C. CANTER, PS 7226 DATE

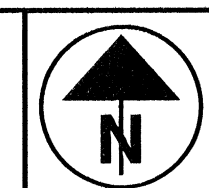

PID NO. 79577

R/W DESIGNER R/W REVIEWER

EXCEPTIONS

HOC/ATH-33-16.52/0.00

6 7

5.502 ACRE EXCEPTION

SITUATE IN THE STATE OF OHIO, HOCKING COUNTY, WARD TOWNSHIP, NORTH HALF OF SECTION 11, T13N, R15W BEING PART OF DEED TRACT 9 CONVEYED TO THE SUNDAY CREEK COAL COMPANY RECORDED IN D.B. 51, PG. 328 OF THE HOCKING COUNTY RECORDER'S OFFICE

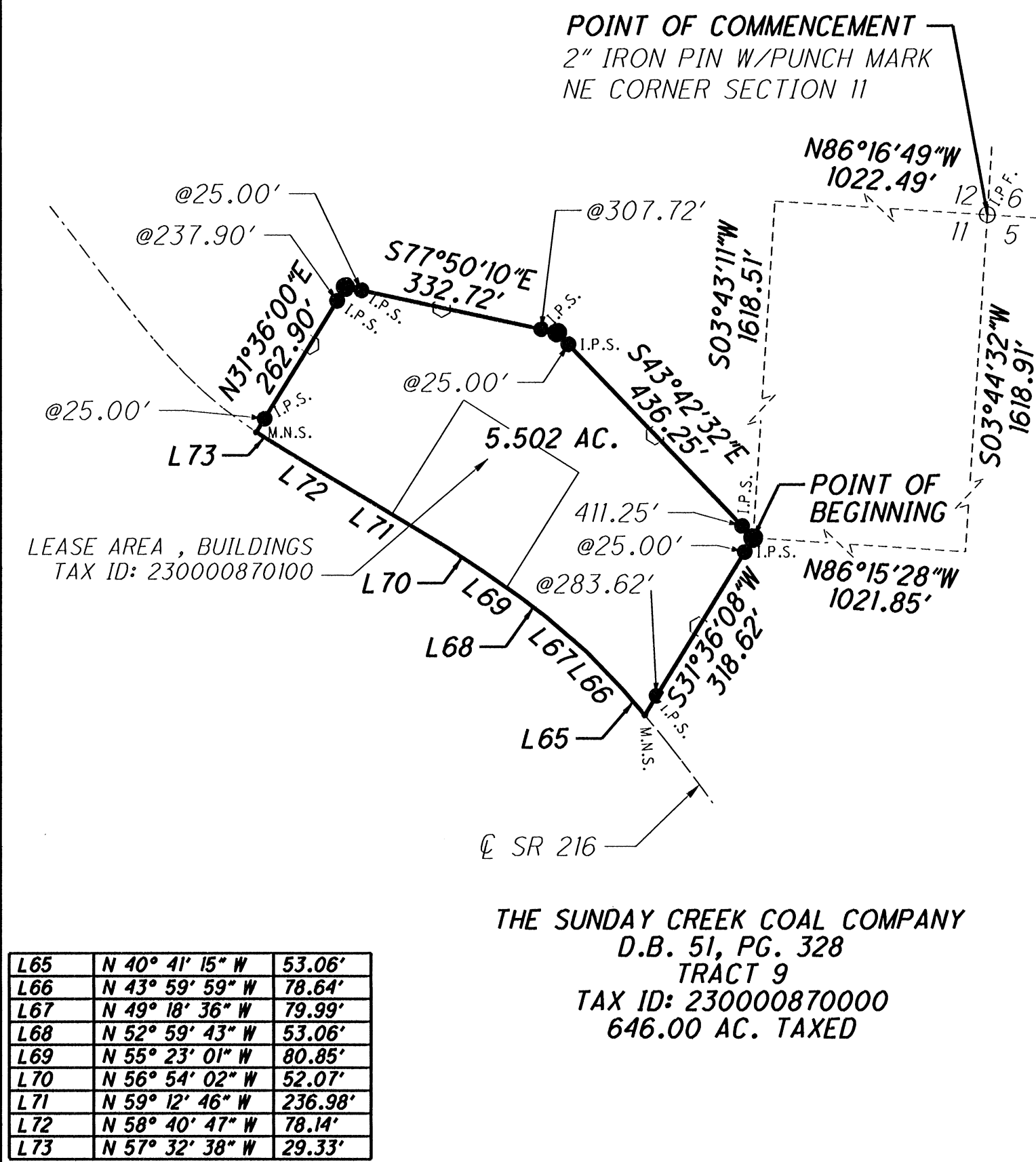

5.315 ACRE EXCEPTION

SITUATE IN THE STATE OF OHIO, HOCKING COUNTY, WARD TOWNSHIP, SOUTHWEST QUARTER OF SECTION 12, FRACTIONAL LOT 4, T13N, R15W BEING PART OF DEED TRACT 10 CONVEYED TO THE SUNDAY CREEK COAL COMPANY RECORDED IN D.B. 51, PG. 328 OF THE HOCKING COUNTY RECORDER'S OFFICE

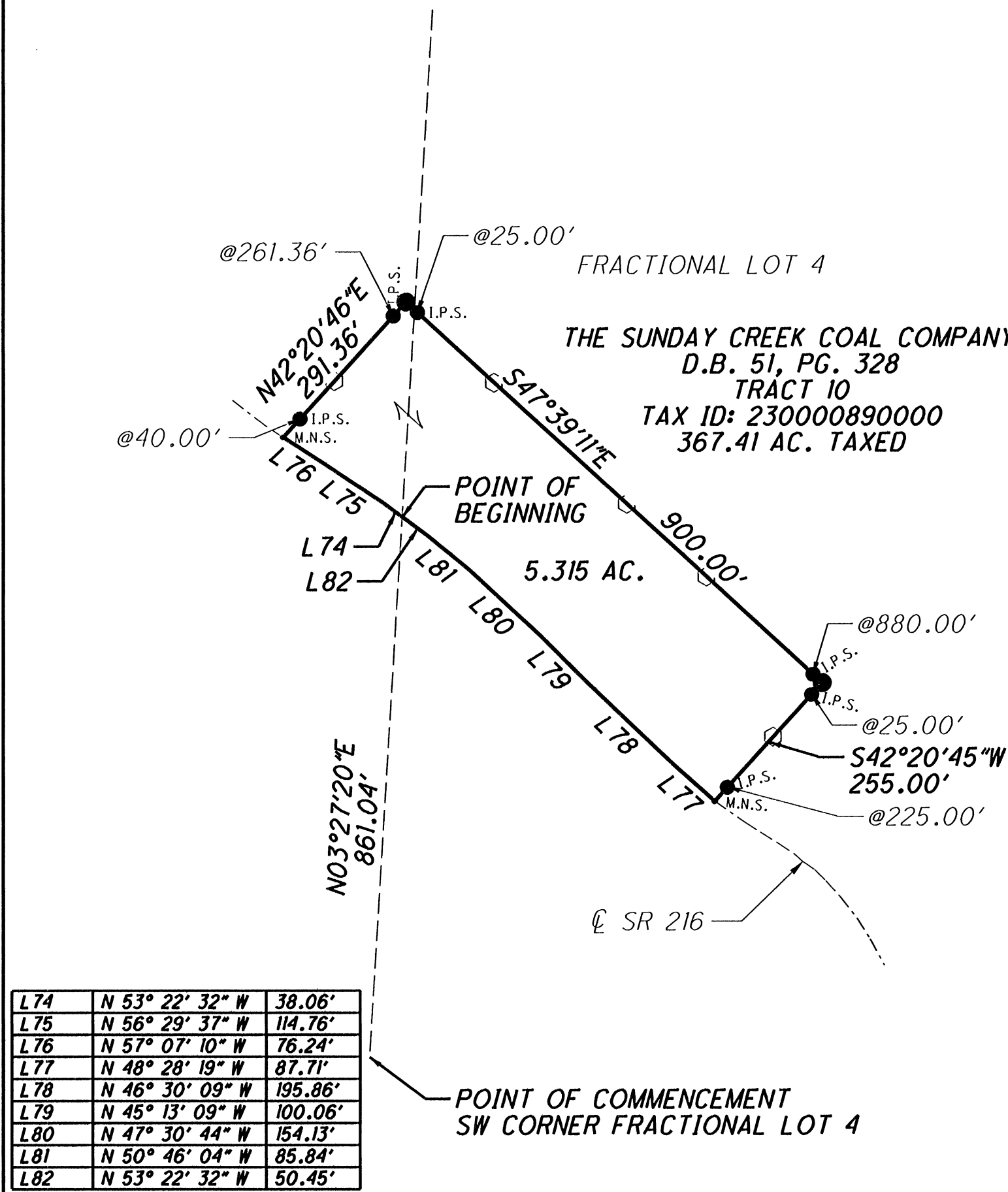

5.134 ACRE EXCEPTION

SITUATE IN THE STATE OF OHIO, HOCKING COUNTY, WARD TOWNSHIP, SOUTHWEST QUARTER OF SECTION 12, T13N, R15W BEING PART OF DEED TRACT 10 CONVEYED TO THE SUNDAY CREEK COAL COMPANY RECORDED IN D.B. 51, PG. 328 OF THE HOCKING COUNTY RECORDER'S OFFICE

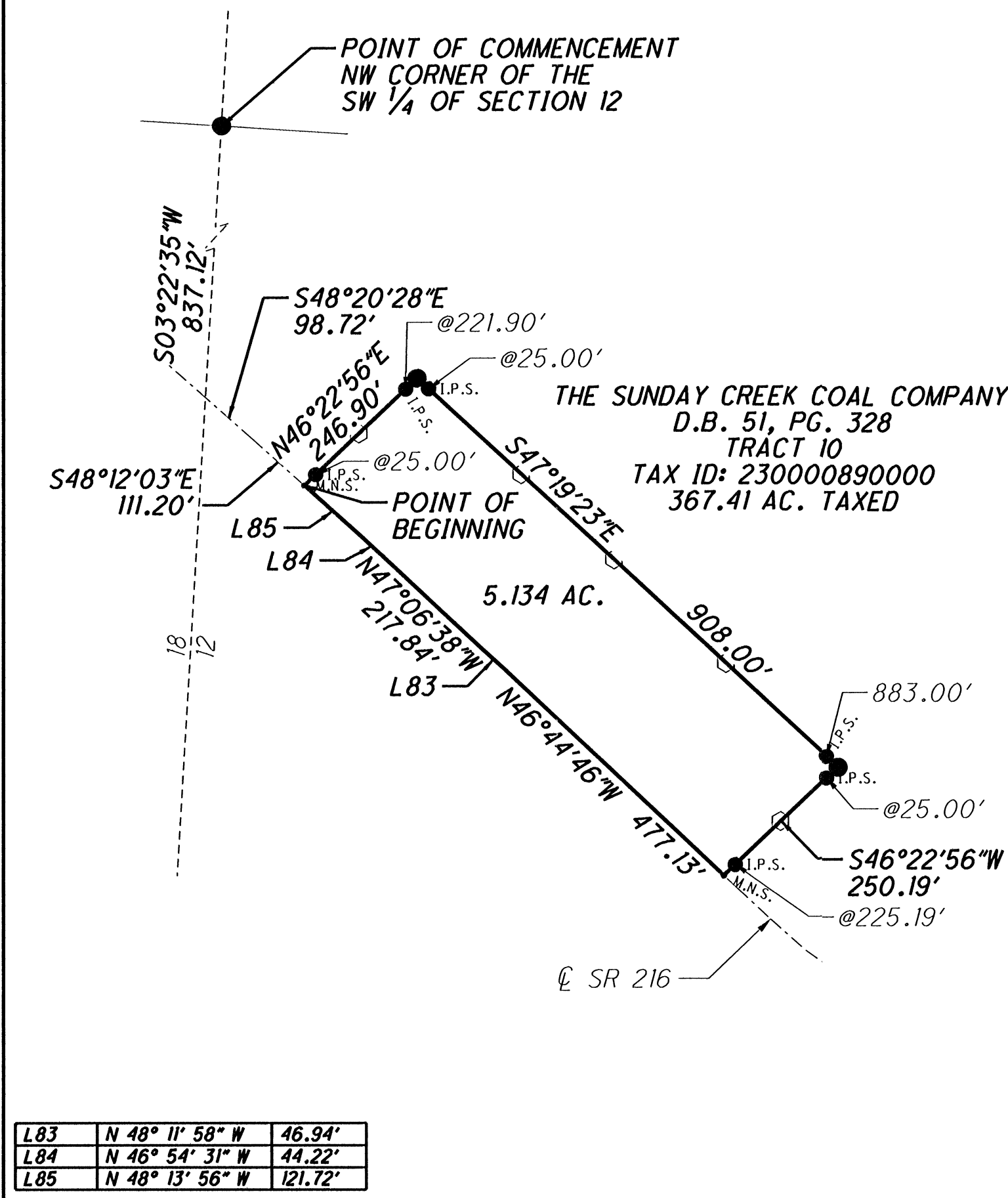

6.641 ACRE EXCEPTION

SITUATE IN THE STATE OF OHIO, HOCKING COUNTY, WARD TOWNSHIP, SOUTHWEST QUARTER OF SECTION 12, SOUTHEAST QUARTER OF SECTION 18, T13N, R15W BEING PART OF DEED TRACT 10 AND 15 CONVEYED TO THE SUNDAY CREEK COAL COMPANY RECORDED IN D.B. 51, PG. 328 OF THE HOCKING COUNTY RECORDER'S OFFICE

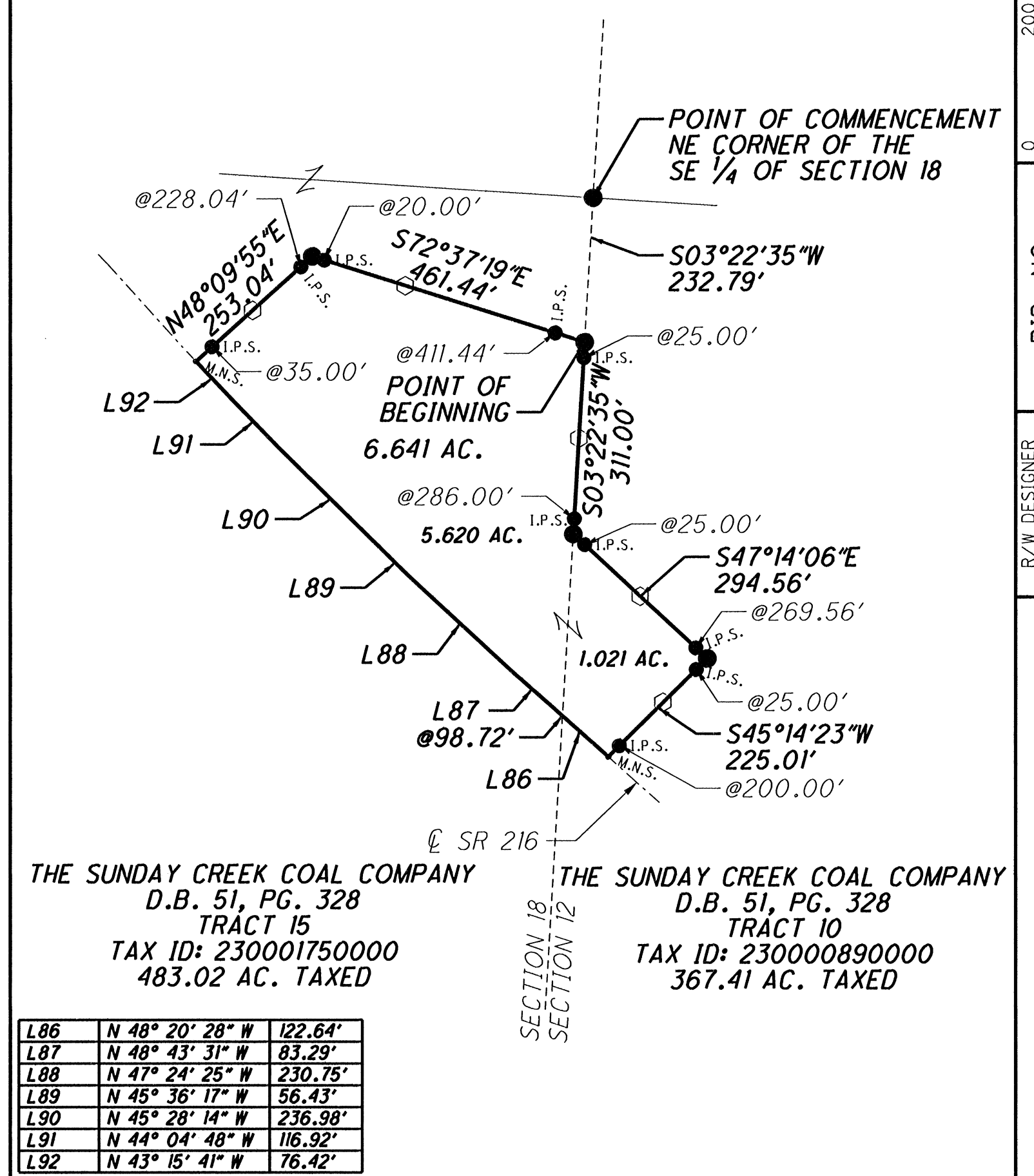

5.909 ACRE EXCEPTION

SITUATE IN THE STATE OF OHIO, HOCKING COUNTY, WARD TOWNSHIP, NORTHEAST AND SOUTHEAST QUARTER OF SECTION 18, T13N, R15W BEING PART OF DEED TRACT 15 CONVEYED TO THE SUNDAY CREEK COAL COMPANY RECORDED IN D.B. 51, PG. 328 OF THE HOCKING COUNTY RECORDER'S OFFICE

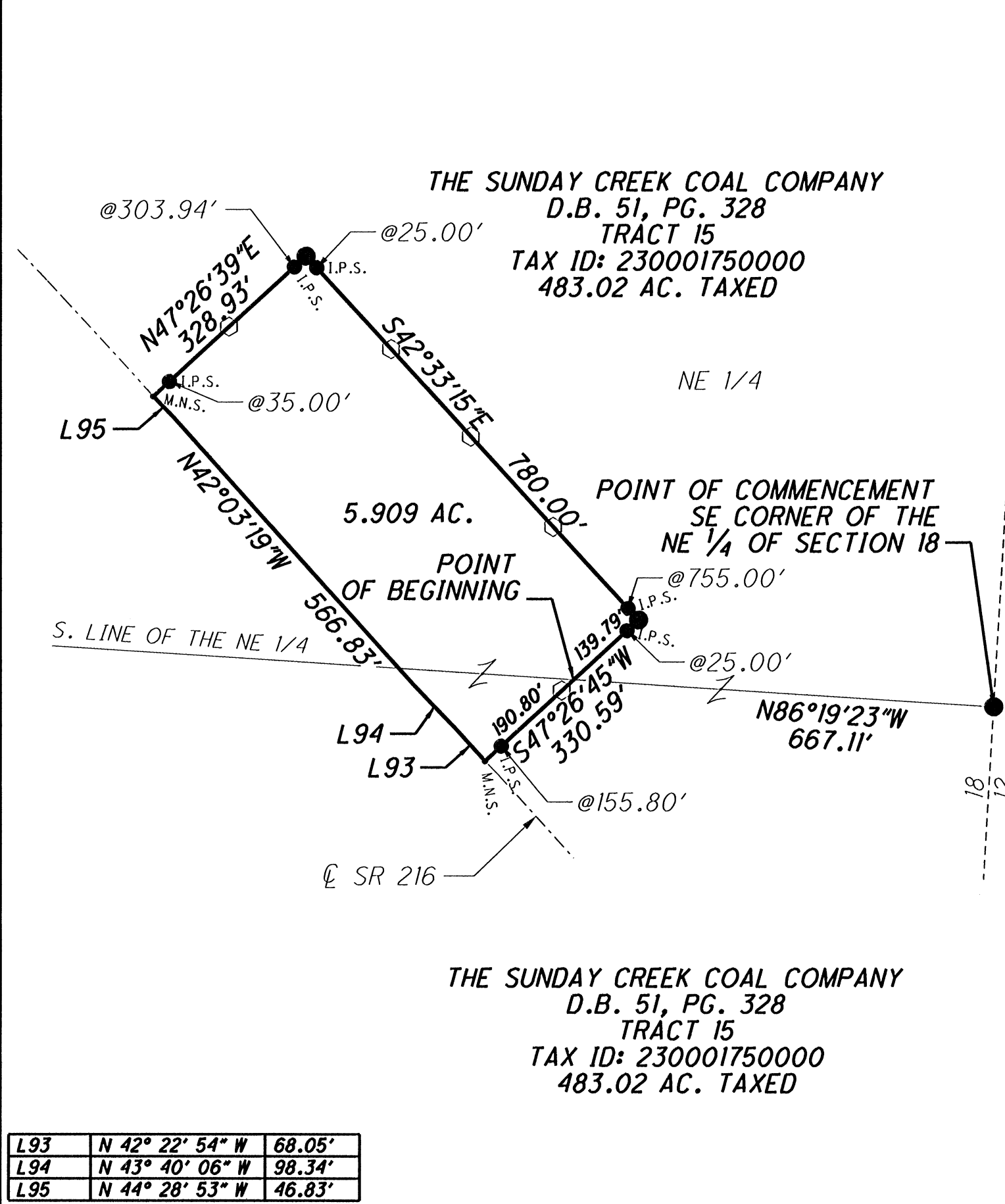

5.380 ACRE EXCEPTION

SITUATE IN THE STATE OF OHIO, HOCKING COUNTY, WARD TOWNSHIP, NORTHEAST QUARTER OF SECTION 18, T13N, R15W BEING PART OF DEED TRACT 15 CONVEYED TO THE SUNDAY CREEK COAL COMPANY RECORDED IN D.B. 51, PG. 328 OF THE HOCKING COUNTY RECORDER'S OFFICE

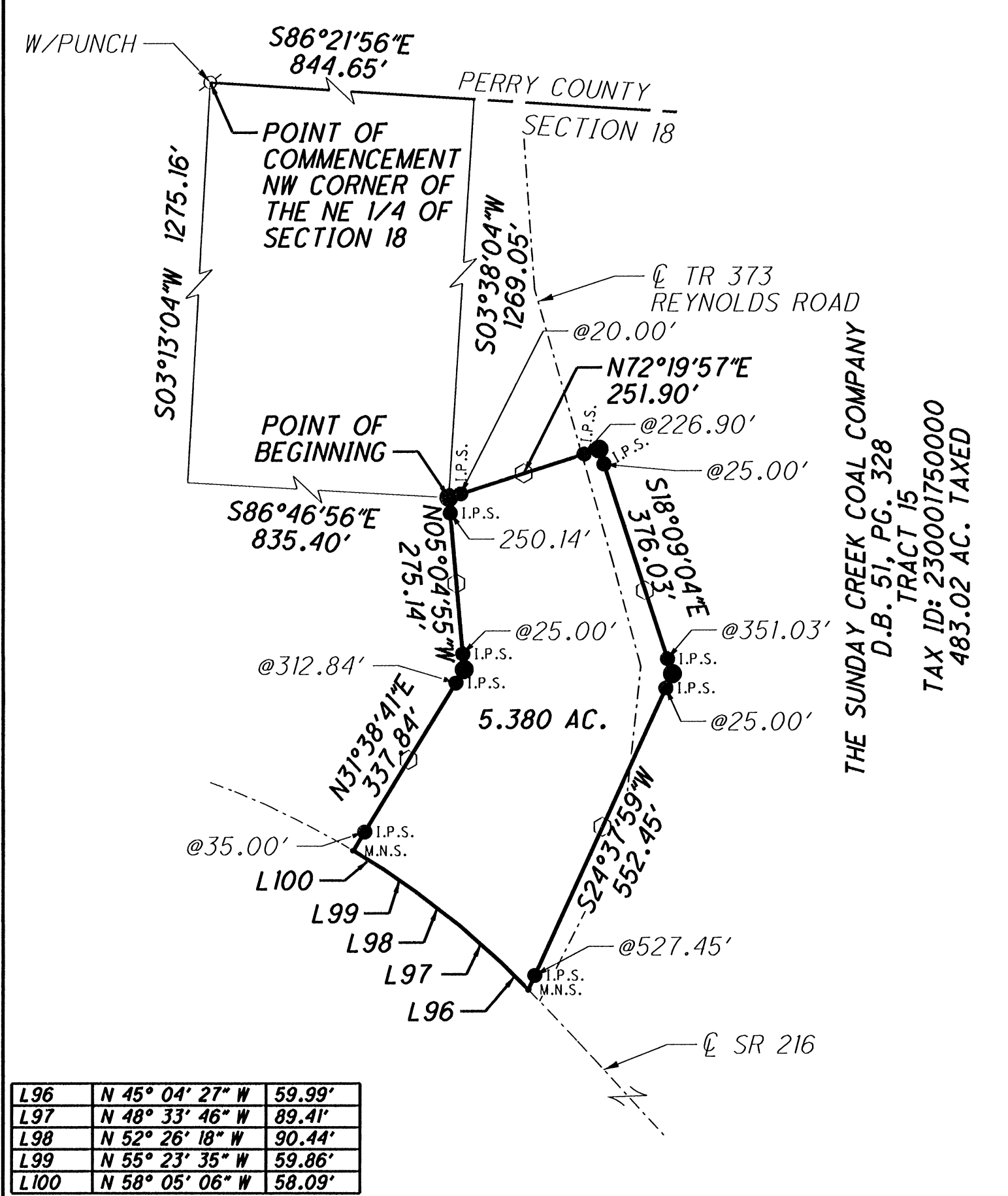

5.148 ACRE EXCEPTION

SITUATE IN THE STATE OF OHIO, HOCKING COUNTY, WARD TOWNSHIP, EAST HALF OF SECTION 16, T13N, R15W BEING PART OF DEED TRACT 13 CONVEYED TO THE SUNDAY CREEK COAL COMPANY RECORDED IN D.B. 51, PG. 328 OF THE HOCKING COUNTY RECORDER'S OFFICE

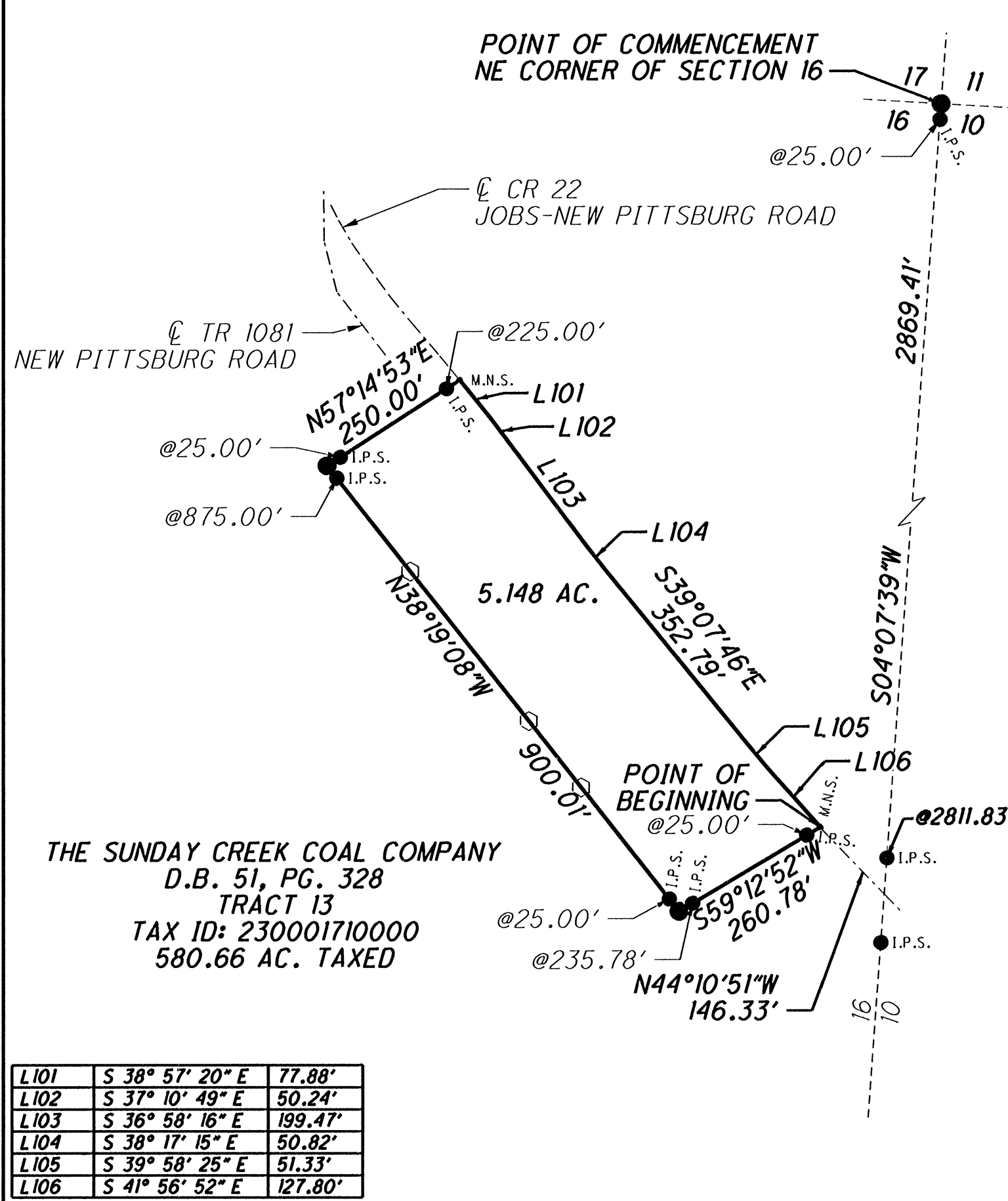

LEGEND

- RAILROAD SPIKE SET
- ⊗ MINE RAIL FOUND
- I.P.F. IRON PIN FOUND
- ⊙ I.P.P. IRON PIPE FOUND
- ⊗ AXLE AXLE FOUND
- ⊠ STONE FOUND
- ☼ TREE
- ⊠ STUMP
- YELLOW OR ORANGE CARSONITE MARKER SET
- M.N.S. MAG NAIL SET
- 2-3/4" D. x 30" L. ALUMINUM ROD SET WITH A 3-1/4" ALUMINUM CAP STAMPED CANTER SURVEYING S 7226
- 3/4" x 30" IRON PIN SET WITH A 3-1/4" ALUMINUM CAP STAMPED CANTER SURVEYING S 7226
- x- FENCE
- - - SECTION LINE
- LOT LINE
- COUNTY LINE

STATE OF OHIO
ROBERT CANTER
REGISTERED PROFESSIONAL SURVEYOR
APPROVED AND AUTHENTICATED
Hocking County Engineer's Office
By: C.J.N. Date: 3/12/12

SURVEYED FEBRUARY 2012 TO JULY 2012 UNDER THE DIRECTION OF ROBERT C. CANTER, P.S. 7226, SUBJECT TO ALL LEGAL EASEMENTS, LEASES AND RIGHTS OF WAY.
R.C.C. 12-3-12
ROBERT C. CANTER, PS 7226 DATE

Exhibit A

Situate in the State of Ohio, Hocking County, Ward Township, Sections 5, 11, 12, 16, 17, 18, 23 and 24, T13N, R15W and being the same as deed tract 4, 9, 10, 13, 14, 15, 19 and part of 18 conveyed to The Sunday Creek Coal Company recorded in D.B. 51, Pg. 328 of the Hocking County Recorder's office and being more particularly described as follows:

Beginning at an 8" x 11" stone found marked with a + referenced by an axle found at the corner common to Sections 15, 16, 21 and 22 being the grantor's southwest corner of deed tract 13, the northwest corner of a 206.00 acre parcel conveyed to the United States of America recorded in D.B. 73, Pg. 126, the northeast corner of a 35.32 acre parcel conveyed to the United States of America recorded in D.B. 73, Pg. 126 and the southeast corner of a 115.45 acre parcel conveyed to conveyed to the United States of America recorded in D.B. 73, Pg. 126;

Thence from the **Point of Beginning** N 04° 03' 00" E 1366.77 feet along the west line of Section 16, the grantor's west line, the east line of said 115.45 acre parcel and the east line of a 322.10 acre parcel conveyed to the United States of America recorded in O.R. 272, Pg. 597 passing an iron pin set at 25.00 feet and at 1341.77 feet to a 3" axle found at the southwest corner of the north half of the southwest quarter and the southwest corner of an 83.668 acre parcel conveyed to Clifton Equities, LLC recorded in O.R. 490, Pg. 70;

Thence S 86° 43' 52" E 2653.99 feet along the south line of said 83.668 acre parcel passing an iron pin set at 25.00 feet, a ¾" iron pin found at 2599.18 feet and an iron pin set at 2628.99 feet to a 2-1/2" axle found at the southeast corner of the north half of the southwest quarter and the southeast corner of said 83.668 acre parcel;

Thence N 03° 48' 49" E 1373.89 feet along the east line of said 83.668 acre parcel passing an iron pin set at 25.00 feet, a ¾" iron pin found at 113.01 feet, a ¾" iron pin found at 1243.14 feet, 0.46 feet left of the line and an iron pin set at 1348.89 feet to a 2" axle found at the northeast corner of the north half of the southwest quarter and the northeast corner of said 83.668 acre parcel;

Thence N 86° 41' 04" W 2648.29 feet along the north line of said 83.668 acre parcel passing an iron pin set at 25.00 feet, a 3/4" iron pin found at 80.76 feet, 0.24 feet left of the line and an iron pin set at 2623.29 feet to a 5/8" iron pin found with a 1-1/4" plastic cap stamped Seymour & Assoc. at the northwest corner of the north half of the southwest quarter and the northwest corner of said 83.668 acre parcel and a point on the east line of said 322.10 acre parcel;

Thence N 04° 03' 00" E 2763.78 feet along the grantor's west line, the west line of Section 16, the east line of Section 22 and the east line of said 322.10 acre parcel passing an iron pin set at 25.00 feet and at 2738.78 feet to an aluminum monument set at the corner common to Sections 16, 17, 22 and 23 and the northeast corner of said 322.10 acre parcel, the northwest corner of the grantor's deed tract 13, the southwest corner of the grantor's deed tract 14 and the southeast corner of the grantor's deed tract 18;

Thence N 86° 38' 07" W 2656.77 feet along the south line of Section 23 passing an iron pin set at 25.00 feet and at 2631.77 feet to an aluminum monument set at the southeast corner of a 72.18 acre parcel conveyed to the United States of America recorded in D.B. 107, Pg. 200, the north line of said 322.10 acre parcel and the southwest corner of the grantor's deed tract 18;

Thence N 04° 12' 29" E 1329.59 feet along the east line of said 72.18 acre parcel passing an iron pin set at 25.00 feet, a 3/4" iron pin found at 1129.36 feet, 1.31 feet left of the line and an iron pin set at 1299.59 feet to a 2" iron pin found at the northeast corner of said 72.18 acre parcel;

Thence N 86° 47' 55" W 1155.92 feet along the north line of said 72.18 acre parcel passing an iron pin set at 25.00 feet, a 3/4" iron pin found at 200.11 feet and a 5/8" iron pin found with a 1-1/4" plastic cap stamped Joseph Roman RS 6461 at 1124.96 feet to a point in the center of C.R. 23 (Sand Run Road);

Thence along the center of C.R. 23 (Sand Run Road) the following forty-four courses;

1. N 07° 23' 27" W 27.45 feet to a point;
2. N 13° 36' 54" W 78.13 feet to a point;
3. N 18° 21' 48" W 94.87 feet to a point;
4. N 19° 29' 24" W 139.99 feet to a point;
5. N 15° 02' 18" W 67.52 feet to a point;
6. N 09° 33' 59" W 73.60 feet to a point;
7. N 06° 03' 54" W 110.78 feet to a point;

8. N 02° 50' 13" W 133.44 feet to a point;
9. N 00° 29' 06" E 109.20 feet to a point;
10. N 05° 06' 14" E 164.24 feet to a point;
11. N 05° 39' 06" E 54.48 feet to a point;
12. N 01° 08' 41" E 211.15 feet to a point;
13. N 05° 43' 25" E 46.66 feet to a point;
14. N 08° 52' 35" E 269.37 feet to a point;
15. N 09° 21' 11" E 225.00 feet to a point;
16. N 06° 46' 29" E 143.25 feet to a point;
17. N 04° 05' 01" E 200.37 feet to a point;
18. N 08° 36' 09" E 77.45 feet to a point;
19. N 13° 04' 43" E 73.77 feet to a point;
20. N 18° 23' 29" E 78.07 feet to a point;
21. N 23° 47' 55" E 72.10 feet to a point;
22. N 27° 45' 41" E 35.65 feet to a point;
23. N 30° 57' 20" E 28.38 feet to a point;
24. N 34° 18' 28" E 26.38 feet to a point;
25. N 42° 09' 18" E 56.15 feet to a point;
26. N 48° 03' 36" E 28.09 feet to a point;
27. N 51° 04' 16" E 173.17 feet to a point;
28. N 46° 02' 52" E 71.34 feet to a point;
29. N 39° 30' 58" E 25.72 feet to a point;
30. N 34° 57' 25" E 26.77 feet to a point;

31. N 25° 28' 27" E 26.70 feet to a point;
32. N 18° 45' 07" E 29.82 feet to a point;
33. N 14° 38' 27" E 26.24 feet to a point;
34. N 07° 04' 42" E 142.49 feet to a point;
35. N 11° 49' 15" E 57.46 feet to a point;
36. N 16° 44' 48" E 56.40 feet to a point;
37. N 20° 16' 02" E 25.28 feet to a point;
38. N 23° 20' 54" E 57.15 feet to a point;
39. N 25° 26' 29" E 334.87 feet to a point;
40. N 21° 59' 17" E 28.01 feet to a point;
41. N 18° 55' 12" E 83.48 feet to a point;
42. N 16° 27' 41" E 53.99 feet to a point;
43. N 14° 14' 53" E 308.74 feet to a point;
44. N 11° 47' 32" E 119.71 feet to a point on the north line of Section 23, the south line of Section 24, the south line of a 462.37 acre parcel conveyed to the United States of America recorded in D.B. 72, Pg. 206 and the northeast corner of a 72.2954 acre parcel conveyed to Larry A. Long and Pamela S. Long recorded in O.R. 357, Pg. 89;

Thence S 86° 40' 31" E 684.55 feet along the north line of Section 23, the south line of Section 24 and the south line of said 462.37 acre parcel passing an iron pin set at 30.11 feet and at 659.55 feet to an aluminum monument set at the southwest corner of the southeast quarter, the southeast corner of said 462.37 acre parcel and the southwest corner of the grantor's deed tract 19;

Thence N 03° 41' 45" E 2693.30 feet along the east line of said 462.37 acre parcel and the east line of a 43.20 acre parcel conveyed to the United States of America recorded in O.R. 230, Pg. 694 passing an iron pin set at 20.00 feet, at 1094.79 feet, at 1154.79 feet and at 2668.30 feet to an aluminum monument set at the northwest corner of the southeast quarter, the northwest corner of the grantor's deed tract 19 and the northeast corner of said 43.20 acre parcel;

Thence S 86° 33' 41" E 2698.84 feet along the north line of the grantor's deed tract 19 and the south line of said 462.37 acre parcel passing an iron pin set at 25.00 feet, 283.95 feet and 343.95 feet to an iron pin set at the northeast corner of the southeast quarter of Section 24, the grantor's northeast corner of deed tract 19, the grantor's northwest corner of deed tract 15, the southwest corner of a 162.12 acre parcel conveyed to the United States of America recorded in D.B. 72, Pg. 206 and the southeast corner of said 462.37 acre parcel;

Thence S 86° 24' 50" E 2620.79 feet along the grantor's north line of deed tract 15 and the south line of said 162.12 acre parcel passing a $\frac{3}{4}$ " iron pin found at 2417.83 feet, 2.54 feet left of the line, and an iron pin set at 2595.79 feet to an aluminum monument set at the southwest corner of the northeast quarter and the southeast corner of said 162.12 acre parcel;

Thence N 03° 13' 04" E 2693.98 feet along the east line of said 162.12 acre parcel passing an iron pin set at 25.00 feet, 1027.96 feet, 1132.11 feet and at 2668.98 feet to a mine rail found with a punch mark at the northwest corner of the northeast quarter of Section 18, the northeast corner of said 162.12 acre parcel, the grantor's northwest corner of deed tract 15 and a point on the Hocking County Line;

Thence S 86° 21' 56" E 2632.80 feet along the north line of Section 18 being the north line of Hocking County passing an iron pin set at 23.00 feet and at 2597.80 feet to an aluminum monument set at the northeast corner of Section 18, the grantor's northeast corner of deed tract 15 and the northwest corner of a 200.00 acre parcel conveyed to the United States of America recorded in D.B. 80, Pg. 20;

Thence S 03° 22' 35" W 2695.88 feet along the east line of Section 18, the west line of Section 12, the east line of the grantor's deed tract 15 and the west line of said 200.00 acre parcel passing an iron pin set at 25.00 feet and at 2670.88 feet to an aluminum monument set at the southwest corner of the northwest corner of Section 12, the southwest corner of said 200.00 acre parcel and the northwest corner of the grantor's deed tract 10;

Thence S 86° 19' 23" E 2625.35 feet along the south line of said 200.00 acre parcel passing an iron pin set at 25.00 feet and at 2600.35 feet to an iron pin set at the southwest corner of the northeast quarter of Section 12 and the southeast corner of said 200.00 acre parcel;

Thence N 03° 32' 05" E 1348.90 feet along the east line of said 200.00 acre parcel passing an iron pin set at 25.00 feet and at 1323.90 feet to an aluminum monument set at the northwest corner of the southwest quarter of the northeast quarter of Section 12 and a point on the east line of said 200.00 acre parcel;

Thence S 86° 20' 40" E 1314.54 feet along the north line of the southwest quarter of the northeast quarter of Section 12 passing an iron pin set at 35.00 feet and at 1289.54 feet to an aluminum monument set at the northeast corner of the southwest quarter of the

northeast quarter of Section 12 and a point on the west line of a 52.8925 acre parcel conveyed to Daniel D. Potter recorded in O.R. 155, Pg. 59;

Thence S 03° 36' 50" W 1349.39 feet along the west line of said 52.8925 acre parcel passing an iron pin set at 25.00 feet and at 1324.39 feet to an aluminum monument set at the southeast corner of the southwest quarter of the northeast quarter of Section 12, the southwest corner of Fractional Lot 2 and the southwest corner of said 52.8925 acre parcel;

Thence S 86° 19' 23" E 1312.67 feet along the south line of Fractional Lot 2, the north line of the south half of Section 12 and the south line of said 52.8925 acre parcel passing an iron pin set at 35.00 feet and at 1287.67 feet to a 4" x 10" stone found with an x at the northeast corner of the south half of Section 12, the southeast corner of said 52.8925 acre parcel, the southwest corner of a 25.0107 acre parcel conveyed to Daniel D. Potter recorded in O.R. 155, Pg. 59 and the northwest corner of a 48.00 acre parcel conveyed to Irene Brundage 1/3 interest, William C. McComas 1/3 interest, Doris J. McComas Wolfe 1/3 interest recorded in D.B. 216, pg. 136;

Thence S 03° 41' 35" W 2699.75 feet along the east line of Section 12 and the west line of said 48.00 acre parcel and the west line of a 78.152 acre parcel conveyed to Leon Kieffer recorded in D.B. 191, Pg. 772 passing an iron pin set at 25.00 feet, a 3/4" iron pin found with a punch mark at 34.44 feet, a 5/8" iron pin found with a 1-1/4" plastic cap stamped PS 6805 found at 705.01 feet 0.54 feet left of the line, a 5/8" iron pin found with a 1-1/4" plastic cap stamped PS 6805 found at 1098.11 feet, a 5/8" iron pin found with a 1-1/4" plastic cap stamped PS 6805 found at 1294.97 feet and an iron pin set at 2674.75 feet to a 2" iron pin found with a punch mark at the corner common to Section 5, 6, 11 and 12, the southwest corner of said 78.152 acre parcel, the southeast corner of the grantor's deed tract 10 and the northwest corner of the grantor's deed tract 4;

Thence S 86° 24' 29" E 1319.02 feet along the north line of Section 5, the south line of said 78.152 acre parcel and the north line of the grantor's deed tract 4 passing an iron pin set at 25.00 feet and at 1294.02 feet to an aluminum monument set at the northeast corner of the west half of the northwest quarter of Section 5, the grantor's northeast corner of deed tract 4, the northwest corner of an 82 acre parcel conveyed to James W. Smith & Melody A. Smith recorded in O.R. 216, Pg. 155 and a point on the south line of said 78.152 acre parcel;

Thence S 03° 44' 32" W 2677.03 feet along the east line of the west half of the northwest quarter of Section 5, the grantor's east line of deed tract 4 and the west line of said 82 acre parcel passing an iron pin set at 40.00 feet and at 2647.03 feet to a 1-1/4" iron pin found in the base of a tree at the southeast corner of the west half of the northwest quarter of Section 5, the southwest corner of said 82 acre parcel, the southeast corner of the grantor's deed tract 4 and a point on the north line of a 326.00 acre parcel conveyed to the United States of America recorded in D.B. 82, Pg. 606;

Thence N 85° 45' 43" W 1319.07 feet along the south line of the west half of the northwest quarter of Section 5, the grantor's south line of deed tract 4 and the north line of said 326.00 acre parcel passing an iron pin set at 25.00 feet and at 1294.07 feet to a 2-1/4" iron pin found with a punch mark at the southwest corner of the west half of the northwest quarter of Section 5, the southwest corner of the grantor's deed tract 4 and the northwest corner of said 326.00 acre parcel;

Thence S 03° 44' 32" W 2670.55 feet along the east line of Section 11 the grantor's east line of deed tract 9 and the west line of said 326.00 acre parcel passing an iron pin set at 25.00 feet, at 199.55 feet and at 292.37 feet, a 5/8" iron pin found with a punch mark at 2595.82 feet and an iron pin set at 2645.55 feet to a 2-1/4" axle found at the corner common to Section 4, 5, 10 and 11, the grantor's southeast corner of deed tract 9, the southwest corner of said 326.00 acre parcel, the northwest corner of a 547.32 acre parcel conveyed to the State of Ohio, Department of Natural Resources recorded in O.R. 436, Pg. 759 and the northeast corner of a 646.00 acre parcel conveyed to the State of Ohio, Department of Natural Resources recorded in O.R. 436, Pg. 759;

Thence N 86° 38' 07" W 5306.43 feet along the north line of Section 10, the south line of Section 11, the South line of the grantor's deed tract 9 and the north line of said 646.00 acre parcel passing an iron pin set at 25.00 feet and at 5281.43 feet to an aluminum monument set at the corner common to Sections 10, 11, 16 and 17, the southwest corner of the grantor's deed tract 9, the northeast corner of the grantor's deed tract 13, the southeast corner of the grantor's deed tract 14 and the northwest corner of said 646.00 acre parcel;

Thence S 04° 07' 39" W 5522.58 feet along the west line of Section 10, the east line of Section 16, the grantor's east line of deed tract 13 and the west line of said 646.00 acre parcel passing an iron pin set at 25.00 feet, at 2811.83 feet, at 2946.41 feet and at 5497.58 feet to an aluminum monument set at the corner common to Sections 9, 10, 15 and 16, the southeast corner of the grantor's deed tract 13, the southwest corner of said 646.00 acre parcel, the northwest corner of a 656.83 acre parcel conveyed to the State of Ohio, Department of Natural Resources recorded in O.R. 436, Pg. 759 and the northeast corner of a 149.10 acre parcel conveyed to the United States of America recorded in O.R. 272, Pg. 597;

Thence N 86° 27' 51" W 5298.80 feet along the north line of Section 15, the south line of Section 16, the south line of the grantor's deed tract 13 and the north line of said 149.10 acre parcel and the north line of a 206.00 acre parcel conveyed to the United States of America recorded in D.B. 73, Pg. 126 passing an iron pin set at 20.00 feet and at 5273.80 feet to the **Point of Beginning**.

The above described contains 3427.721 acres more or less.

Excepting 55.708 acres described below.

Situate in the State of Ohio, Hocking County, Ward Township, Section 23, Fractional Lots 2, 3 and 4 T13N, R15W and being more particularly described as follows:

Commencing at a 3" iron pin found at the corner common to Sections 17, 18, 23 and 24, and the northeast corner of Fractional Lot 6, thence S 05° 14' 19" W 1284.88 feet along the east line of Section 23 and the east line of Fractional Lot 6 to an iron pin set at the northeast corner of Fractional Lot 3 and the northeast corner of a 22.763 acre parcel conveyed to C. Scott Walters and Julie A. Walters recorded in O.R. 405, Pg. 426, said iron pin set being the **Point of Beginning** for the parcel herein described;

Thence from the **Point of Beginning** S 05° 14' 19" W 1415.29 feet along the east line of Fractional Lot 3 passing an iron pin set at 25.00 feet and at 1390.29 feet to an aluminum monument set at the southeast corner of Fractional Lot 3, the northeast corner of Fractional Lot 2 and the southeast corner of a 3.54 acre parcel conveyed to William Naffziger and Colleen Naffziger recorded in O.R. 410, Pg. 103;

Thence N 86° 18' 58" W 335.97 feet along the south line of Fractional Lot 3, the north line of Fractional Lot 2 and the south line of said 3.54 acre parcel passing an iron pin set at 35.00 feet and at 302.54 feet to a railroad spike set in the center of County Road 22 (Jobs-New Pittsburg Road);

Thence S 33° 26' 00" E 100.00 feet along a new division line and along the center of County Road 22 (Jobs-New Pittsburg Road) passing a ¾" iron pin found at 37.02 feet to a railroad spike set;

Thence S 89° 54' 26" W 91.88 feet along a new division line to an aluminum monument set passing an iron pin set at 25.00 feet;

Thence N 25° 05' 25" W 97.88 feet along a new division line to an aluminum monument set on the north line of Fractional Lot 2 and the south line of fractional Lot 3;

Thence N 86° 18' 58" W 794.69 feet along the south line of Fractional Lot 3 and the north line of Fractional Lot 2 passing an iron pin set at 774.66 feet to a railroad spike set in the center of Township Road 22 (Burton Hill Road);

Thence S 29° 18' 48" E 210.15 feet along a new division line and the center of Township Road 22 (Burton Hill Road) to a railroad spike set;

Thence S 73° 05' 00" W 77.06 feet along a new division line to an aluminum monument set passing an iron pin set at 25.00 feet;

Thence N 57° 45' 30" W 95.34 feet along a new division line to an aluminum monument set;

Thence N 32° 03' 36" W 194.41 feet along a new division line to an aluminum monument set on the North Line of Fractional Lot 2 and the south line of Fractional Lot 3;

Thence N 86° 18' 58" W 1334.15 feet along the north line of Fractional Lot 2 and the south line of Fractional Lot 3 passing the southwest corner of Fractional Lot 3 and the southeast corner of Fractional Lot 4 at 271.06 feet and an iron pin set at 1309.15 feet to an aluminum monument set at the southwest corner of Fractional Lot 4 and the southwest corner of a 1.96 acre parcel conveyed to Shyana Bookman recorded in O.R. 469, Pg. 684;

Thence N 04° 41' 42" E 85.80 feet along the west line of Fractional Lot 4 and the west line of said 1.96 acre parcel to an aluminum monument set at the northwest corner of said 1.96 acre parcel;

Thence S 85° 46' 57" E 1063.35 feet along the north line of said 1.96 acre parcel passing an iron pin set at 25.00 feet and at 1038.35 feet to an aluminum monument set at the northeast corner of said 1.96 acre parcel, a point on the east line of Fractional Lot 4, a point on the west line of Fractional Lot 3 and the west line of a 5.483 acre parcel conveyed to Shyana K. Bookman recorded in O.R. 469, Pg. 684;

Thence N 04° 59' 09" E 1304.56 feet along the east line of Fractional Lot 4 and the west line of Fractional Lot 3 passing an iron pin set at 25.00 feet, at 709.59 feet, at 770.54 feet and at 1279.56 feet to an iron pin set at the northeast corner of Fractional Lot 4, the northwest corner of Fractional Lot 3, the south line of Fractional Lot 5 and the northwest corner of an 8.924 acre parcel conveyed to C. Scott Walters and Julie A. Walters recorded in O.R. 405, Pg. 424;

Thence S 86° 24' 01" E 307.54 feet along the north line of Fractional Lot 3, the south line of Fractional Lot 5 and the north line of said 8.924 acre parcel passing an iron pin set at 30.00 feet and at 282.54 feet to an aluminum monument set at the southeast corner of Fractional Lot 5;

Thence N 03° 16' 24" E 32.10 feet along the east line of Fractional Lot 5 to an aluminum monument set at the southwest corner of Fractional Lot 6;

Thence S 86° 24' 25" E 1334.89 feet along the south line of Fractional Lot 6 and the north line of Fractional Lot 3 passing an iron pin set at 25.00 feet and at 1309.89 feet to the **Point of Beginning**.

The above described contains 55.708 acres more or less.

Excepting 0.773 acres described below.

Situate in the State of Ohio, Hocking County, Ward Township, Section 12, Fractional Lot 5, T13N, R15W and being the same exception described in the deed tract

10 conveyed to The Sunday Creek Coal Company recorded in D.B. 51, Pg. 328 of the Hocking County Recorder's office and being more particularly described as follows:

Commencing at the southwest corner of Fractional Lot 4, thence S 86° 16' 49" E 599.48 feet along the south line of Fractional Lot 4 to an aluminum monument set, said aluminum monument set being the **Point of Beginning** for the parcel herein described;

Thence N 03° 43' 11" E 212.35 feet passing an iron pin set at 25.00 feet and at 199.85 feet to a point in the center of the creek;

Thence along the center of the creek the following eleven courses;

1. S 59° 09' 21" E 80.76 feet to a point;
2. S 79° 12' 02" E 34.44 feet to a point;
3. S 77° 31' 06" E 28.49 feet to a point;
4. S 86° 05' 49" E 46.83 feet to a point;
5. S 23° 37' 47" E 21.50 feet to a point;
6. S 09° 07' 41" E 20.82 feet to a point;
7. S 03° 10' 15" E 34.24 feet to a point;
8. S 18° 25' 02" W 18.64 feet to a point;
9. S 30° 54' 09" W 20.06 feet to a point;
10. S 22° 00' 57" W 39.08 feet to a point;
11. S 17° 40' 07" E 21.94 feet to a point on the south line of Section 12;

Thence N 86° 16' 49" W 181.50 feet along the south line of Section 12 passing an iron pin set at 25.00 feet and at 156.50 feet to the **Point of Beginning**.

The above described contains 0.773 acres more or less. Current deed unknown. No Auditor's Permanent Parcel Number.

Excepting 0.333 acres described below.

Situate in the State of Ohio, Hocking County, Ward Township, south half of the southwest quarter of Section 16, T13N, R15W and being the same exception described in the deed tract 13 conveyed to The Sunday Creek Coal Company recorded in D.B. 51, Pg.

328 of the Hocking County Recorder's office. Current deed unknown. No Auditor's Permanent Parcel Number.

Excepting 5.148 acres described below.

Situate in the State of Ohio, Hocking County, Ward Township, east half of Section 16, T13N, R15W and being part of deed tract 13 conveyed to The Sunday Creek Coal Company recorded in D.B. 51, Pg. 328 of the Hocking County Recorder's office and being more particularly described as follows:

Commencing at an aluminum monument set at the northeast corner of Section 16, thence S 04° 07' 39" W 2869.41 feet along the east line of Section 16 to a point in the center of County Road 22 (Jobs-New Pittsburg Road) passing an iron pin set at 25.00 feet and at 2811.83 feet, thence N 44° 10' 51" W 146.33 feet along the center of Jobs-New Pittsburg Road to a mag nail set, said mag nail set being the **Point of Beginning** for the parcel herein described;

Thence from the **Point of Beginning** across the grantor the following three courses;

1. S 59° 12' 52" W 260.78 feet across the grantor to an aluminum monument set passing an iron pin set at 25.00 feet and at 235.78 feet;
2. N 38° 19' 08" W 900.01 feet to an aluminum monument set passing an iron pin set at 25.00 feet and at 875.00 feet;
3. N 57° 14' 53" E 250.00 feet to a mag nail set in the center of Jobs-New Pittsburg Road passing an iron pin set at 25.00 feet and at 225.00 feet;

Thence along the center of Jobs-New Pittsburg Road the following seven courses;

1. S 38° 57' 20" E 77.88 feet to a point;
2. S 37° 10' 49" E 50.24 feet to a point;
3. S 36° 58' 16" E 199.47 feet to a point;
4. S 38° 17' 15" E 50.82 feet to a point;
5. S 39° 07' 46" E 352.79 feet to a point;
6. S 39° 58' 25" E 51.33 feet to a point;
7. S 41° 56' 52" E 127.80 feet to the **Point of Beginning**.

The above described contains 5.148 acres more or less and is contained in Auditor's Permanent Parcel Number 230001710000 which presently shows 580.66 acres.

Excepting 5.380 acres described below.

Situate in the State of Ohio, Hocking County, Ward Township, northeast quarter of Section 18, T13N, R15W and being part of deed tract 15 conveyed to The Sunday Creek Coal Company recorded in D.B. 51, Pg. 328 of the Hocking County Recorder's office and being more particularly described as follows:

Commencing at a mine rail found with a punch mark at the northwest corner of the northeast quarter of Section 18, thence S 03° 13' 04" W 1275.16 feet along the west line of the northeast quarter of Section 18 to a point, thence S 86° 46' 56" E 835.40 feet across the grantor to an aluminum monument set, said aluminum monument set being the **Point of Beginning** for the parcel herein described;

Thence from the **Point of Beginning** across the grantor the following three courses;

1. N 72° 19' 57" E 251.90 feet to a an aluminum monument set passing an iron pin set at 20.00 feet and at 226.90 feet;
2. S 18° 09' 04" E 376.03 feet to a an aluminum monument set passing an iron pin set at 25.00 feet and at 351.03 feet;
3. S 24° 37' 59" W 552.45 feet to a mag nail set in the center of SR 216 passing an iron pin set at 25.00 feet and at 527.45 feet;

Thence along the center of SR 216 the following five courses;

1. N 45° 04' 27" W 59.99 feet to a point;
2. N 48° 33' 46" W 89.41 feet to a point;
3. N 52° 26' 18" W 90.44 feet to a point;
4. N 55° 23' 35" W 59.86 feet to a point;
5. N 58° 05' 06" W 58.09 feet to a mag nail set;

Thence N 31° 38' 41" E 337.84 feet across the grantor to an aluminum monument set passing an iron pin set at 35.00 feet and at 312.84 feet;

Thence N 05° 04' 55" W 275.14 feet across the grantor to the **Point of Beginning** passing an iron pin set at 25.00 feet and at 250.14 feet.

The above described contains 5.380 acres more or less and is contained in Auditor's Permanent Parcel Number 230001750000 which presently shows 483.02 acres.

Excepting 5.909 acres described below.

Situate in the State of Ohio, Hocking County, Ward Township, northeast and southeast quarter of Section 18, T13N, R15W and being part of deed tract 15 conveyed to The Sunday Creek Coal Company recorded in D.B. 51, Pg. 328 of the Hocking County Recorder's office and being more particularly described as follows:

Commencing at an aluminum monument set at the southeast corner of the northeast quarter of Section 18, thence N 86° 19' 23" W 667.11 feet along the south line of the northeast quarter of Section 18 to a point, said point being the **Point of Beginning** for the parcel herein described;

Thence from the **Point of Beginning** S 47° 26' 45" W 190.80 feet across the grantor to a mag nail set in the center of SR 216 passing an iron pin set at 155.80 feet;

Thence along the center of SR 216 the following four courses;

1. N 42° 22' 54" W 68.05 feet to a point;
2. N 43° 40' 06" W 98.34 feet to a point;
3. N 42° 03' 19" W 566.83 feet to a point;
4. N 44° 28' 53" W 46.83 feet to a mag nail set;

Thence across the grantor the following three courses;

1. N 47° 26' 39" E 328.93 feet to an aluminum monument set passing an iron pin set at 35.00 feet and at 303.94 feet;
2. S 42° 33' 15" E 780.00 feet to an aluminum monument set passing an iron pin set at 25.00 feet and at 755.00 feet;
3. S 47° 26' 45" W 139.79 feet to the **Point of Beginning** passing an iron pin set at 25.00 feet.

The above described contains 5.909 acres more or less and is contained in Auditor's Permanent Parcel Number 230001750000 which presently shows 483.02 acres.

Excepting 6.641 acres described below.

Situate in the State of Ohio, Hocking County, Ward Township, southwest quarter of Section 12, southeast quarter of Section 18, T13N, R15W and being part of deed tract

10 and 15 conveyed to The Sunday Creek Coal Company recorded in D.B. 51, Pg. 328 of the Hocking County Recorder's office and being more particularly described as follows:

Commencing at an aluminum monument set at the northeast corner of the southeast quarter of Section 18, thence S 03° 22' 35" W 232.79 feet along the west line of Section 12 to an aluminum monument set, said aluminum monument set being the **Point of Beginning** for the parcel herein described;

Thence from the **Point of Beginning** S 03° 22' 35" W 311.00 feet along the west line of Section 12 to an aluminum monument set passing an iron pin set at 25.00 feet and at 286.00 feet;

Thence S 47° 14' 06" E 294.56 feet across the grantor to an aluminum monument set passing an iron pin set at 25.00 feet and at 269.56 feet;

Thence S 45° 14' 23" W 225.01 feet across the grantor to a mag nail set in the center of SR 216 passing an iron pin set at 25.00 feet and at 200.00 feet;

Thence along the center of SR 216 the following seven courses;

1. N 48° 20' 28" W 122.64 feet to a point passing the west line of Section 12 at 98.72 feet;
2. N 48° 43' 31" W 83.29 feet to a point;
3. N 47° 24' 25" W 230.75 feet to a point;
4. N 45° 36' 17" W 56.43 feet to a point;
5. N 45° 28' 14" W 236.98 feet to a point;
6. N 44° 04' 48" W 116.92 feet to a point;
7. N 43° 15' 41" W 76.42 feet to a mag nail set;

Thence N 48° 09' 55" E 253.04 feet across the grantor to an aluminum monument set passing an iron pin set at 35.00 feet and at 228.04 feet;

Thence S 72° 37' 19" E 461.44 feet across the grantor to the **Point of Beginning** passing an iron pin set at 20.00 feet and at 411.44 feet.

The above described contains 6.641 acres more or less (1.021 acres in Section 12 from Auditor's Permanent Parcel Number 230000890000 which presently shows 367.41 acres and 5.620 acres in Section 18 from Auditor's Permanent Parcel Number 230001750000 which presently shows 483.02 acres).

Excepting 5.134 acres described below.

Situate in the State of Ohio, Hocking County, Ward Township, southwest quarter of Section 12, T13N, R15W and being part of deed tract 10 conveyed to The Sunday Creek Coal Company recorded in D.B. 51, Pg. 328 of the Hocking County Recorder's office and being more particularly described as follows:

Commencing at an aluminum monument set at the northwest corner of the southwest quarter of Section 12, thence S 03° 22' 35" W 837.12 feet along the west line of Section 12 to a point in the center of SR 216, thence S 48° 20' 28" E 98.72 feet along the center of SR 216 to a point, thence S 48° 12' 03" E 111.20 feet along the center of SR 216 to a mag nail set, said mag nail set being the **Point of Beginning** for the parcel herein described;

Thence from the **Point of Beginning** across the grantor the following three courses;

1. N 46° 22' 56" E 246.90 feet to an aluminum monument set passing an iron pin set at 25.00 feet and at 221.90 feet;
2. S 47° 19' 23" E 908.00 feet to an aluminum monument set passing an iron pin set at 25.00 feet and at 883.00 feet;
3. S 46° 22' 56" W 250.19 feet to a mag nail set in the center of SR 216 passing an iron pin set at 25.00 feet and at 225.19 feet;

Thence along the center of SR 216 the following five courses;

1. N 46° 44' 46" W 477.13 feet to a point;
2. N 48° 11' 58" W 46.94 feet to a point;
3. N 47° 06' 38" W 217.84 feet to a point;
4. N 46° 54' 31" W 44.22 feet to a point;
5. N 48° 13' 56" W 121.72 feet to the **Point of Beginning**.

The above described contains 5.134 acres more or less and is contained in Auditor's Permanent Parcel Number 230000890000 which presently shows 367.41 acres.

Excepting 5.315 acres described below.

Situate in the State of Ohio, Hocking County, Ward Township, southwest quarter of Section 12, Fractional Lot 4, T13N, R15W and being part of deed tract 10 conveyed to

The Sunday Creek Coal Company recorded in D.B. 51, Pg. 328 of the Hocking County Recorder's office and being more particularly described as follows:

Commencing at the southwest corner of Fractional Lot 4, thence N 03° 27' 20" E 861.04 feet along the west line of Fractional Lot 4 to a point in the center of SR 216, said point being the **Point of Beginning** for the parcel herein described;

Thence from the **Point of Beginning** along the center of SR 216 the following three courses;

1. N 53° 22' 32" W 38.06 feet to a point;
2. N 56° 29' 37" W 114.76 feet to a point;
3. N 57° 07' 10" W 76.24 feet to a mag nail set;

Thence across the grantor the following three courses;

1. N 42° 20' 46" E 291.36 feet to an aluminum monument set passing an iron pin set at 40.00 feet and at 261.36 feet;
2. S 47° 39' 11" E 900.00 feet to an aluminum monument set passing an iron pin set at 25.00 feet and at 880.00 feet;
3. S 42° 20' 45" W 255.00 feet to a mag nail set in the center of SR 216 passing an iron pin set at 25.00 feet and at 225.00 feet;

Thence along the center of SR 216 the following six courses;

1. N 48° 28' 19" W 87.71 feet to a point;
2. N 46° 30' 09" W 195.86 feet to a point;
3. N 45° 13' 09" W 100.06 feet to a point;
4. N 47° 30' 44" W 154.13 feet to a point;
5. N 50° 46' 04" W 85.84 feet to a point;
6. N 53° 22' 32" W 50.45 feet to the **Point of Beginning**.

The above described contains 5.315 acres more or less and is contained in Auditor's Permanent Parcel Number 230000890000 which presently shows 367.41 acres.

Excepting 5.502 acres described below.

Situate in the State of Ohio, Hocking County, Ward Township, north half of Section 11, T13N, R15W and being part of deed tract 9 conveyed to The Sunday Creek Coal Company recorded in D.B. 51, Pg. 328 of the Hocking County Recorder's office and being more particularly described as follows:

Commencing at a 2" iron pin found with a punch mark at the northeast corner of Section 11, thence S 03° 44' 32" W 1618.91 feet along the east line of Section 11 to a point, thence N 86° 15' 28" W 1021.85 feet across the grantor to an aluminum monument set, said aluminum monument set being the **Point of Beginning** for the parcel herein described;

Thence from the **Point of Beginning** S 31° 36' 08" W 318.62 feet across the grantor to a mag nail set in the center of SR 216 passing an iron pin set a 25.00 feet and at 283.62 feet;

Thence along the center of SR 216 the following nine courses;

1. N 40° 41' 15" W 53.06 feet to a point;
2. N 43° 59' 59" W 78.64 feet to a point;
3. N 49° 18' 36" W 79.99 feet to a point;
4. N 52° 59' 43" W 53.06 feet to a point;
5. N 55° 23' 01" W 80.85 feet to a point;
6. N 56° 54' 02" W 52.07 feet to a point;
7. N 59° 12' 46" W 236.98 feet to a point;
8. N 58° 40' 47" W 78.14 feet to a point;
9. N 57° 32' 38" W 29.33 feet to a mag nail set;

Thence N 31° 36' 00" E 262.90 feet across the grantor to an aluminum monument set passing an iron pin set at 25.00 feet and at 237.90 feet;

Thence S 77° 50' 10" E 332.72 feet across the grantor to an aluminum monument set passing an iron pin set at 25.00 feet and at 307.72 feet;

Thence S 43° 42' 32" E 436.25 feet across the grantor to the **Point of Beginning** passing an iron pin set at 25.00 feet and at 411.25 feet;

The above described contains 5.502 acres more or less and is contained in Auditor's Permanent Parcel Number 230000870000 which presently shows 646.00 acres

and all of Auditor's Permanent Parcel Number 230000870100 which presently is for buildings on leased property.

The above described contains **3331.878** acres more or less after exceptions and is contained in Auditor's Permanent Parcel Number 230001710000 which presently shows 580.66 acres (**582.099** ac. surveyed) in Section 16, 230001730000 which presently shows 663.00 acres (**651.219** ac. surveyed) in Section 17, 230003070000 which presently shows 377.40 acres (**385.565** ac. surveyed) in Section 23, 230003220000 which presently shows 165.00 acres (**167.483** ac. surveyed) in Section 24, 230001750000 which presently shows 483.02 acres (**469.735** ac. surveyed) in Section 18, 230000890000 which presently shows 367.41 acres (**353.172** ac. surveyed) in Section 12, 230000870000 which presently shows 646.00 acres (**641.768** ac. surveyed) in Section 11 and 230000310000 which presently shows 81.00 acres (**80.837** ac. surveyed) in Section 5.

Subject to all legal easements, leases and rights of way.

All iron pins set are 3/4"D x 30"L rebar with a 3-1/4" aluminum cap stamped Canter Surveying S 7226 referenced with a carsonite marker.

All aluminum monuments set are 2-3/4"D x 30"L with a 3-1/4" aluminum cap stamped Canter Surveying S 7226 referenced with a carsonite marker.

This description was prepared under the direction and supervision of Robert C. Canter, Registered Surveyor No. 7226 and is based on a field survey made by Canter Surveying/GPS Services, Inc., completed July 2012.

Prior Instrument Reference: D.B. 51, Pg. 328 of the Hocking County Recorder's Office.

Bearings are NAD 83(CORS), Ohio State Plane, South Zone Grid. Based on GPS observations. Reference NGS CORS station OHHO having a Latitude of 39° 32' 07.27648" N and a Longitude of 82° 26' 37.87659" W. Reference the west line of Section 16 as being N 04° 03' 00" E.

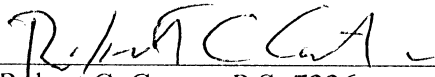
Robert C. Canter, P.S. 7226

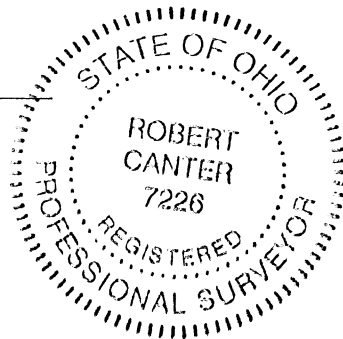

12-3-12
Date

APPROVED MATHEMATICALLY
Hocking County Engineer's Office
By: CW Date: M. 12 D. 3 Y. 2012